



Fig.1 Power Dissipation

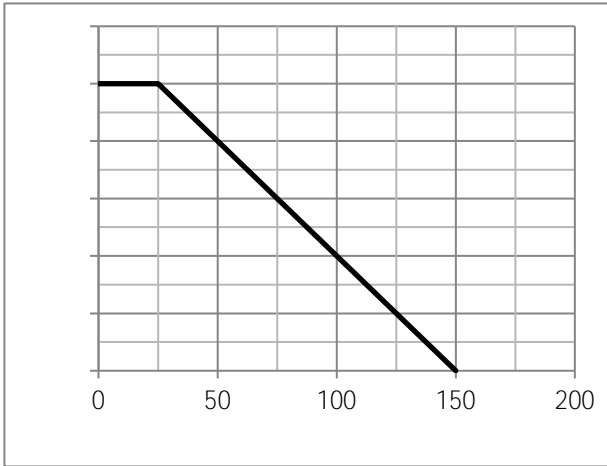

Fig.2 Typical output Characteristics

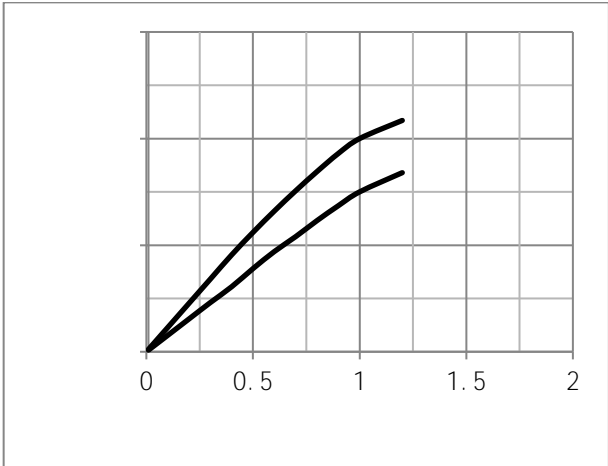

Fig.3 Threshold Voltage V.S Junction Temperature

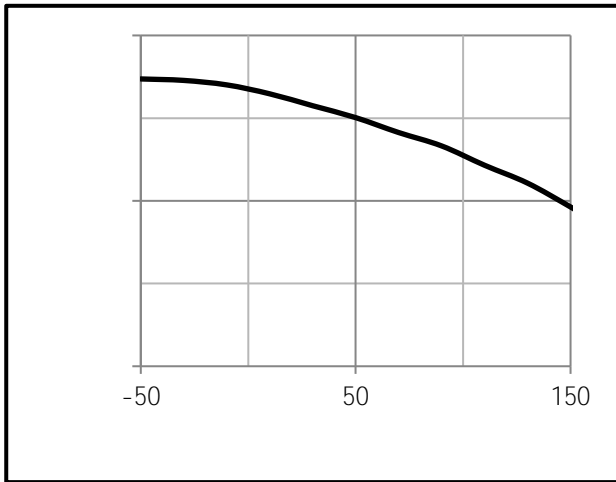

Fig.4 Resistance V.S Drain Current

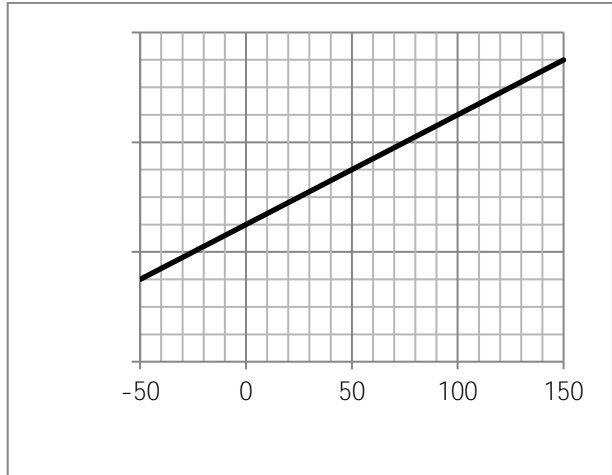
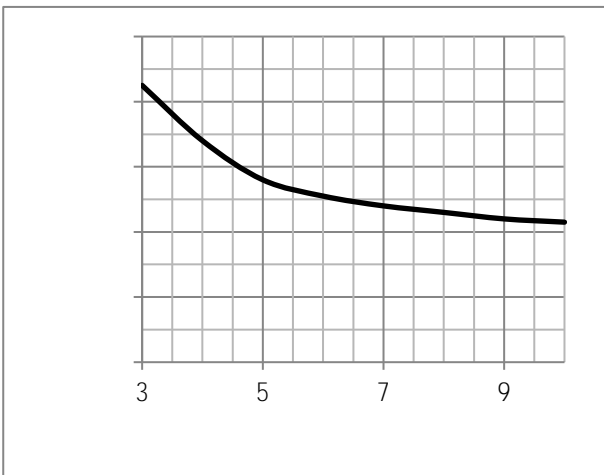
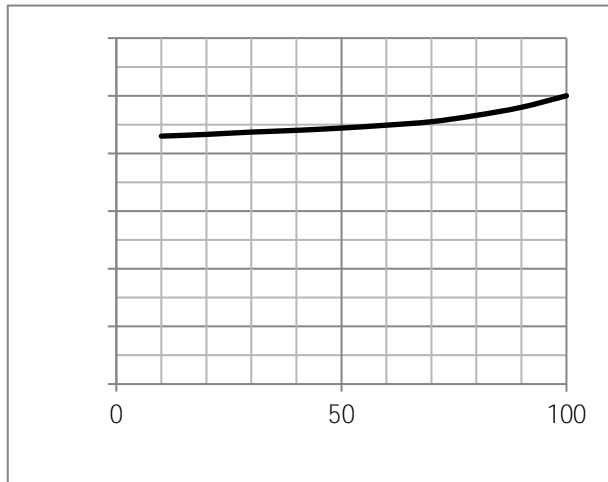



Fig.7 Switching Time Measurement Circuit

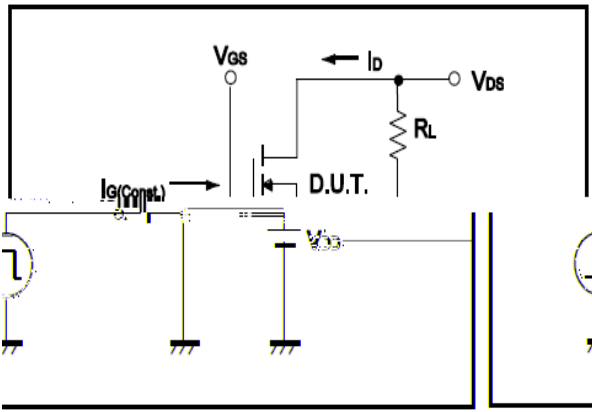

Fig.8 Gate Charge Waveform

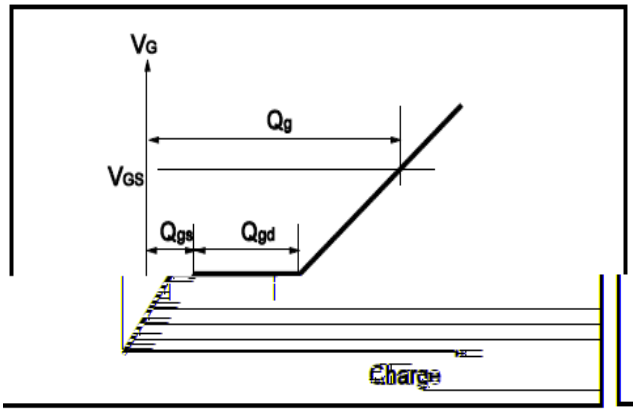

Fig.9 Switching Time Measurement Circuit

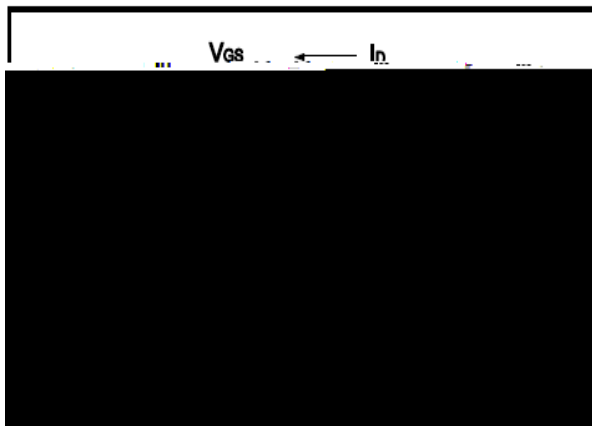

Fig.10 Gate Charge Waveform

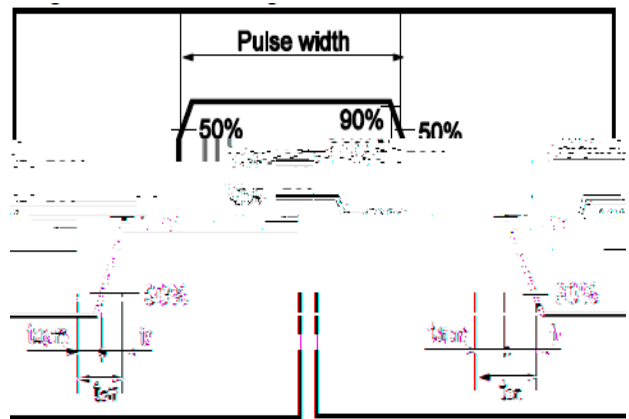

Fig.11 Avalanche Measurement Circuit

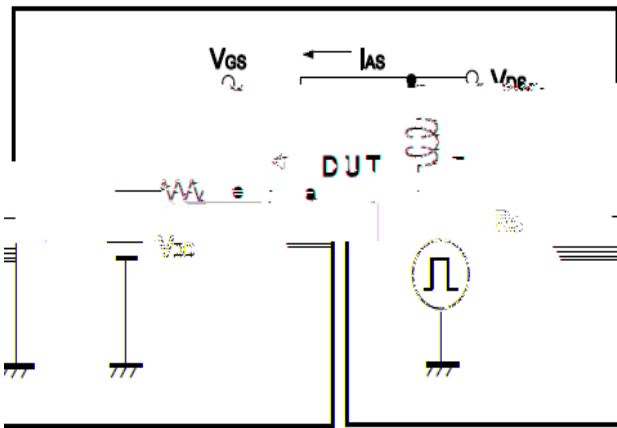
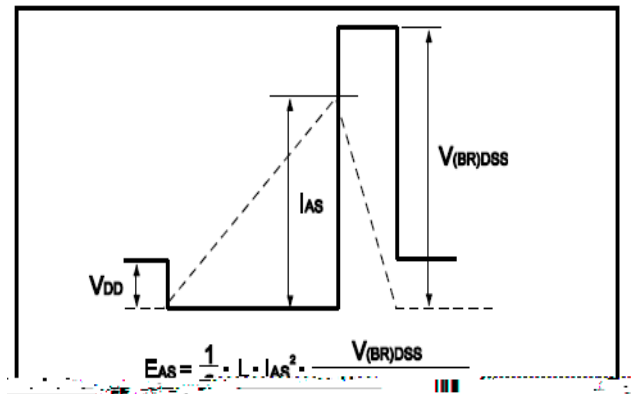

Fig.12 Avalanche Waveform





Dimensions DFN5x6

Unit mm

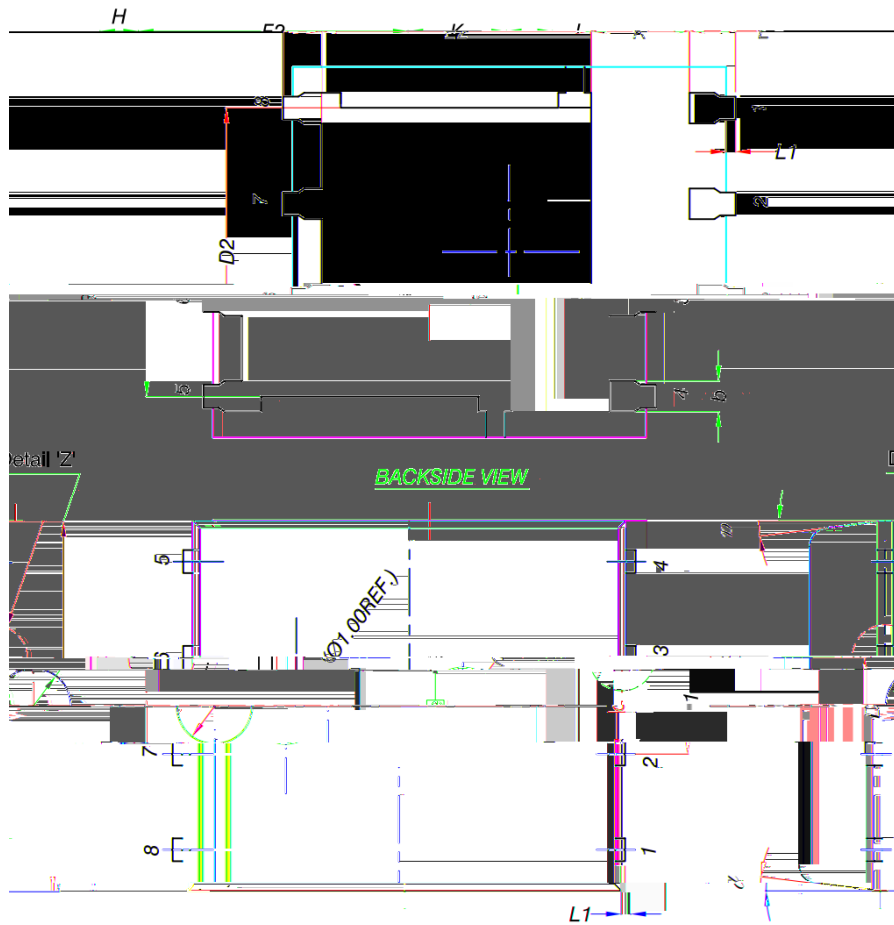

DIM	MILLIMETERS		
	MIN	TYP	MAX
A1	0.95	1.00	1.10
A2	0		0.95
B1	0.28	0.47	0.51
C1	0.09	0.25	0.25
D1		4.80	4.90
D2		3.61	3.81
E		5.90	6.00
E1		5.70	5.75
E2		3.25	
E2-BSC			
e		0.6	
H		0.2	
K		0.75	
L		0.4	
L1		0.4	
L2		0.2	
L3		0.2	
L4		0.2	
L5		0.2	
L6		0.2	
L7		0.2	
L8		0.2	
L9		0.2	
L10		0.2	
L11		0.2	
L12		0.2	