

(T_C =25°C)

Parameter	Symbol	Rating	Unit
Drain-Source Voltage	V _{DS}	80	V
Gate-Source Voltage	V _{GS}	±20	V
Continuous Drain Current(TC=25°C)	I _{D@TC=25°C}	80	A
	I _{D@TC=75°C}	60	A
		50	

PJc0 G[Veds)15(D)-4(r)3(a)11(i)-4(n 1)

"Ó



Fig.1 Gate-Charge Characteristics

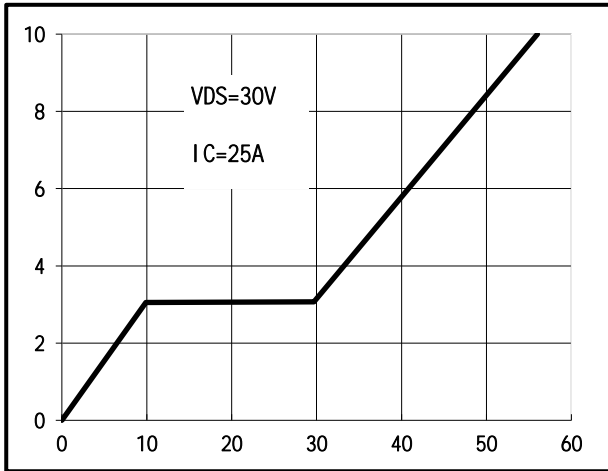

Fig.2 Capacitance Characteristics

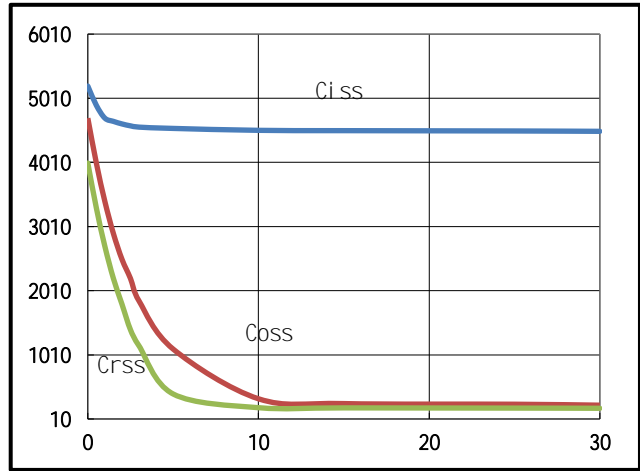

Fig.3 Power Dissipation

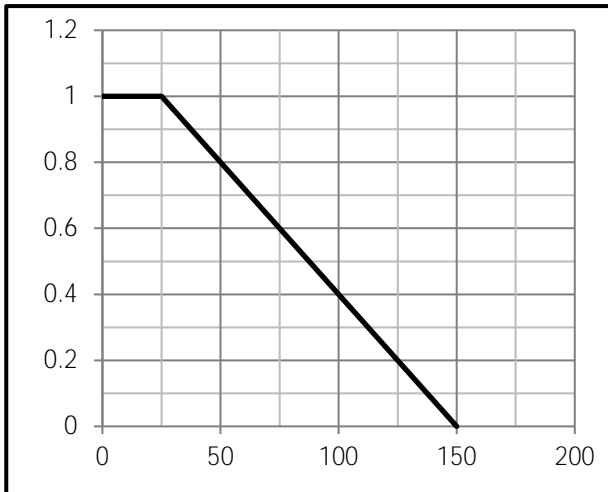

Fig.4 Typical output Characteristics

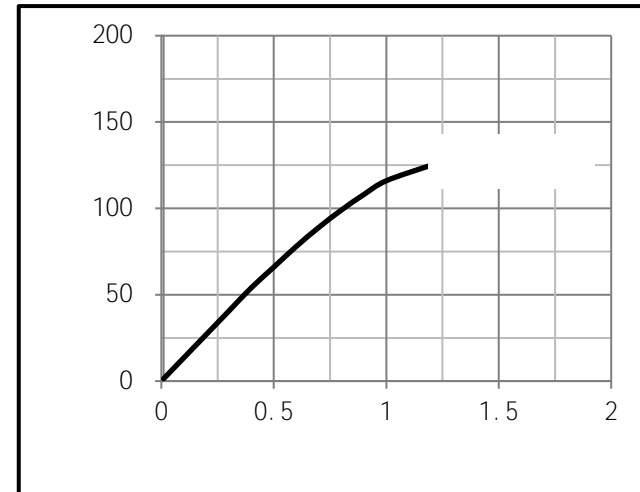

Fig.5 Threshold Voltage V.S Junction Temperature

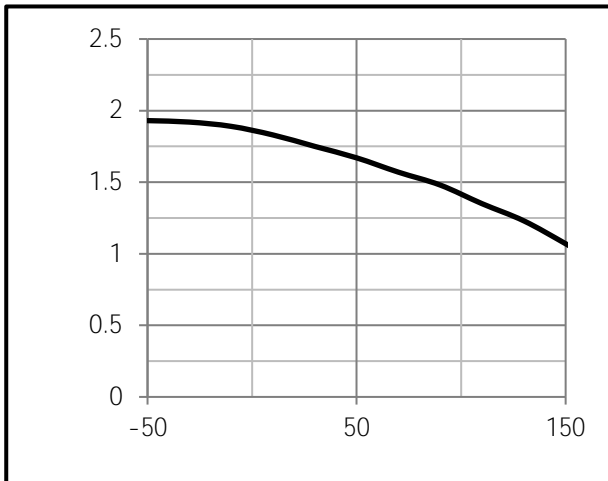
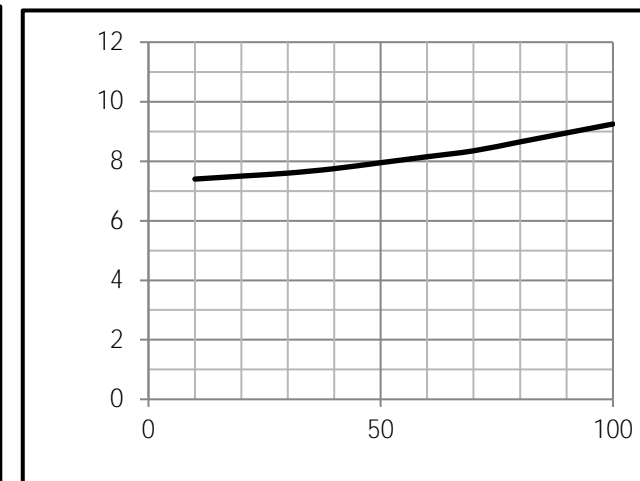

Fig.6 Resistance V.S Drain Current



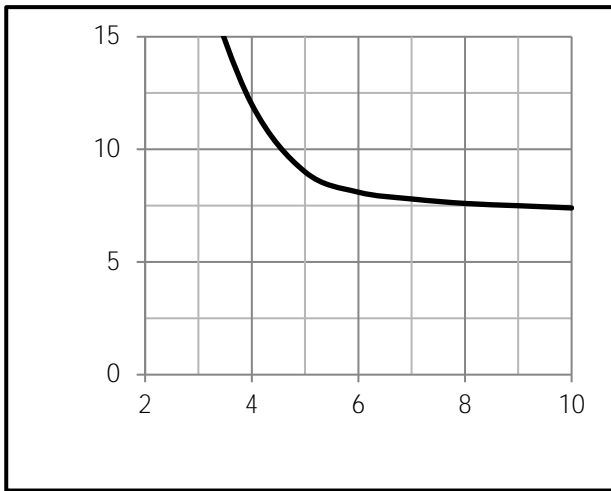

Fig.9 Switching Time Measurement Circuit

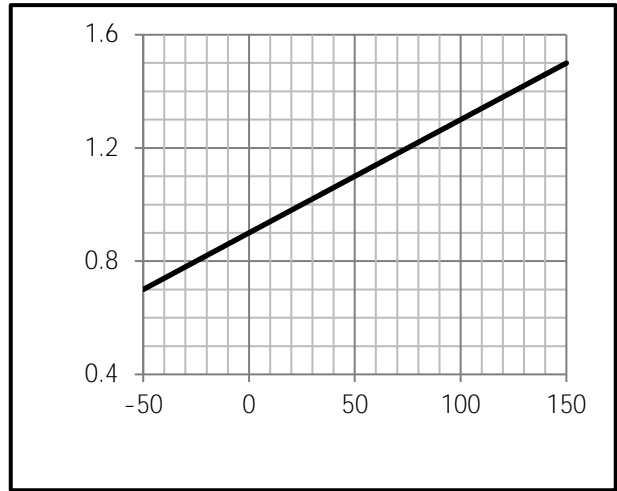

Fig.10 Gate Charge Waveform

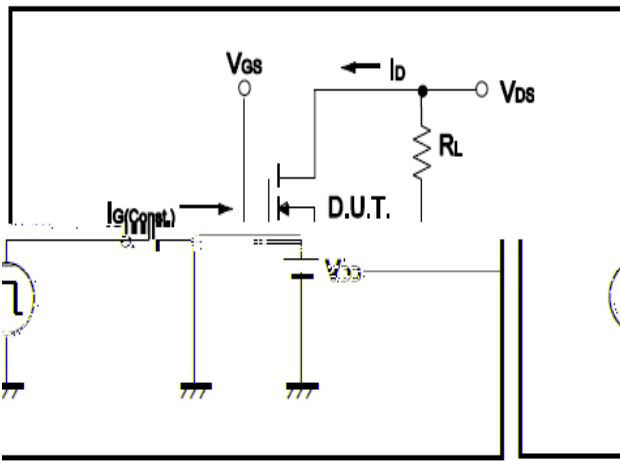

Fig.11 Switching Time Measurement Circuit

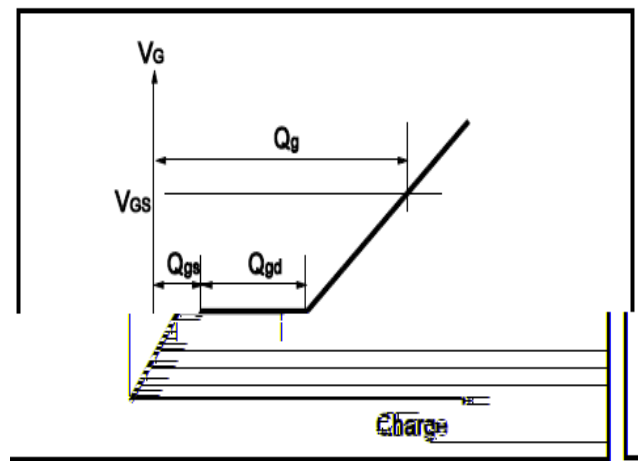
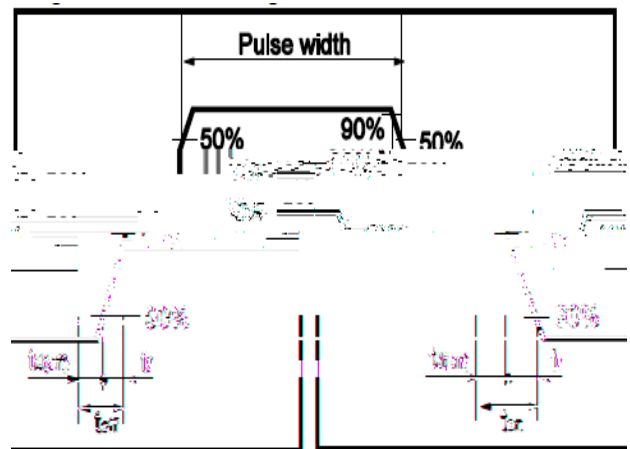
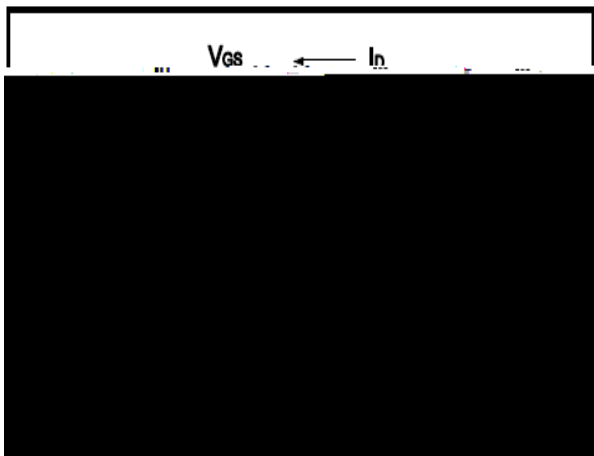

Fig.12 Gate Charge Waveform





(DFN5x6)

Unit mm

