

**Product Summary**

The ZMD68204U combines advanced trench MOSFET technology with a low resistance package to provide extremely low  $R_{DS(ON)}$ .

Trench technology  
 $R_{DS(ON)}$  to minimize conductive loss

Dual DIE in one package

Power Management in Notebook Computer,  
 Portable Equipment and Battery Powered  
 Systems

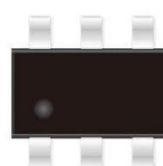
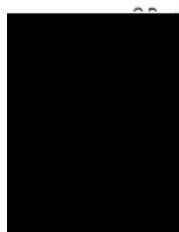

Part NO.	ZMD68204U
Marking	68204
Packing Information	REEL TAPE
Basic ordering unit (pcs)	3000

**Ratings  $T_C = 25$** 

Parameter	Symbol	Rating	Unit
Drain-Source Voltage	$V_{DS}$	20	V
Gate-Source Voltage	$V_{GS}$	$\pm 12$	V
Continuous Drain Current	$I_{D@TC=25}$	5	A
	$I_{D@TC=75}$	3.8	A
	$I_{D@TC=100}$	3.2	A
Pulsed Drain Current	$I_{DM}$	11	A
Total Power Dissipation( $TC=25$ )	$P_D@TC=25$	3.6	W
Total Power Dissipation( $TA=25$ )	$P_D@TA=25$	0.69	W
Operating Junction Temperature	$T_J$	-55 to 150	
Storage Temperature	$T_{STG}$	-55 to 150	
Single Pulse Avalanche Energy	$E_{AS}$	20	mJ





Fig.1 Power Dissipation

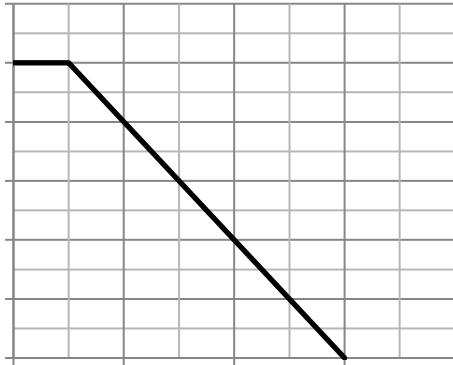

Fig.2 Typical output Characteristics

Fig.3 Threshold Voltage V.S Junction Temperature

Fig.4 Resistance V.S Drain Current



Fig.7 Switching Time Measurement Circuit

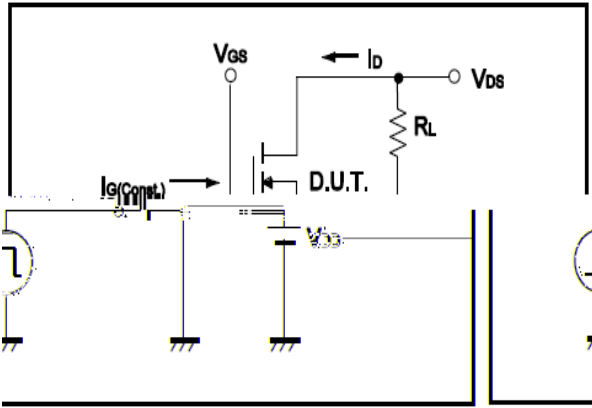

Fig.8 Gate Charge Waveform

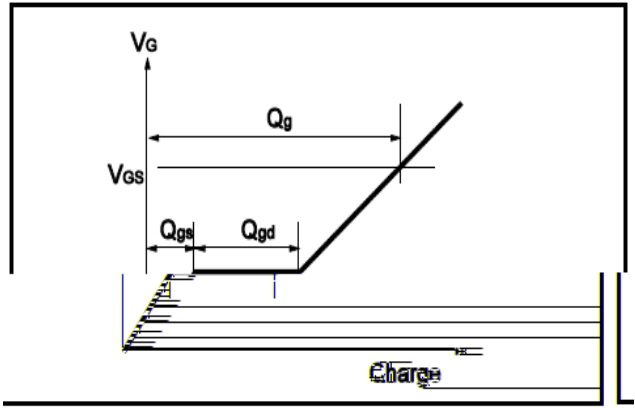

Fig.9 Switching Time Measurement Circuit

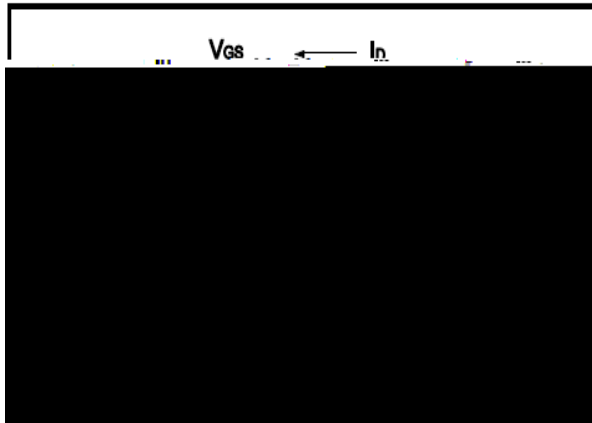

Fig.10 Gate Charge Waveform

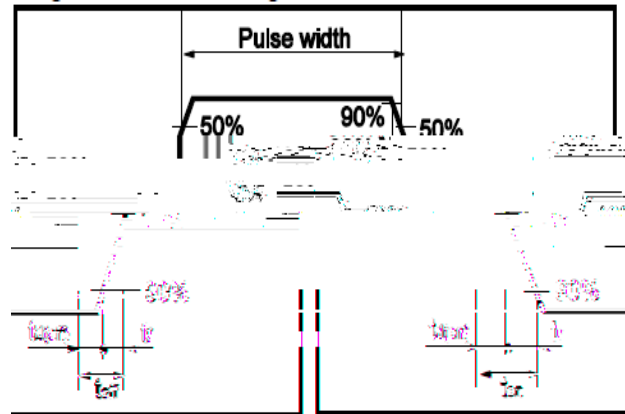

Fig.11 Avalanche Measurement Circuit

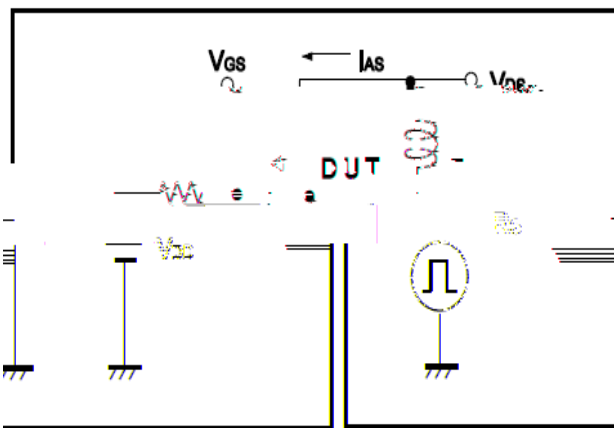
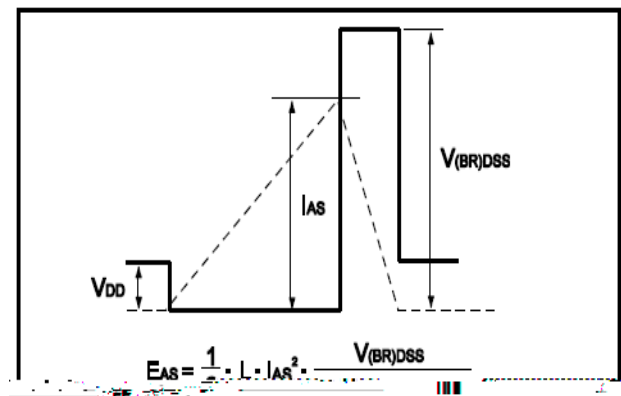

Fig.12 Avalanche Waveform





(SOT23-6)

Unit: mm

