



$T_C = 25$

Parameter	Symbol	Rating	Unit
Drain-Source Voltage	$V_{DS}$	60	V
Gate-Source Voltage	$V_{GS}$	$\pm 20$	V
Continuous Drain Current	$I_{D@TC=25}$	35	A
	$I_{D@TC=75}$	26	A
	$I_{D@TC=100}$	22	A
Pulsed Drain Current	$I_{DM}$	105	A





Fig.1 Gate-Charge Characteristics

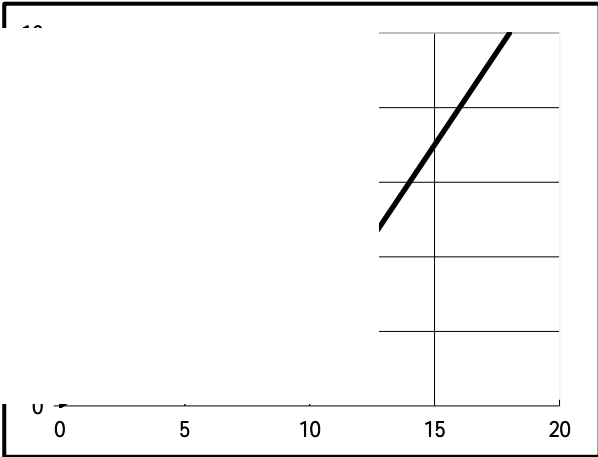

Fig.2

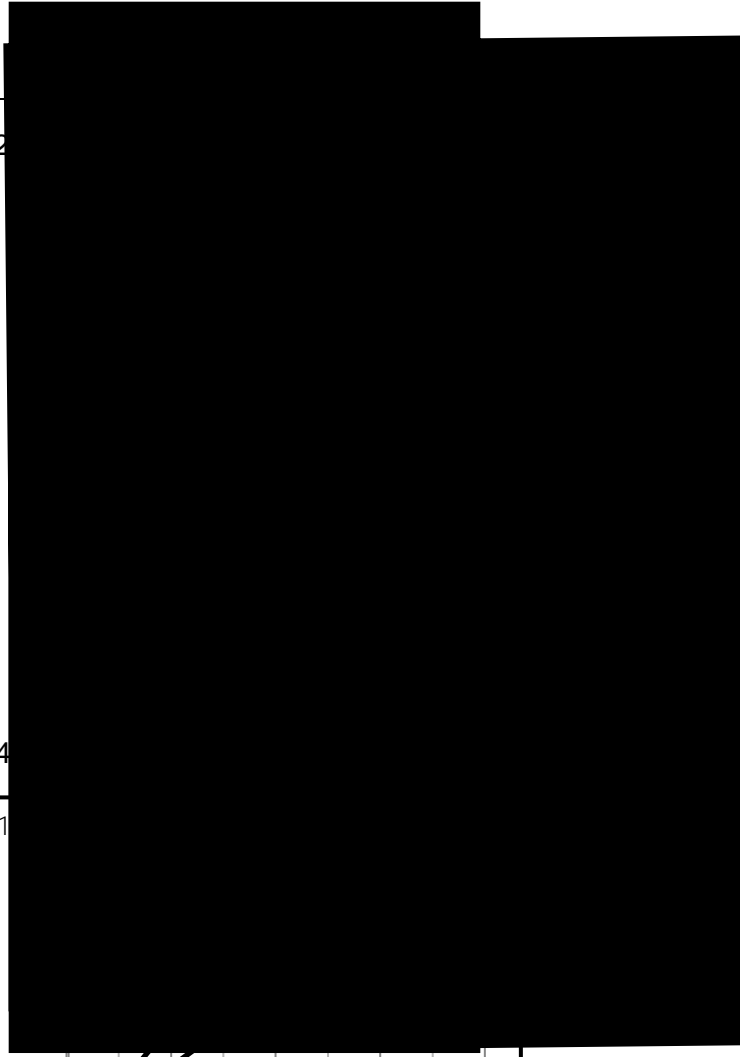

Fig.3 Power Dissipation

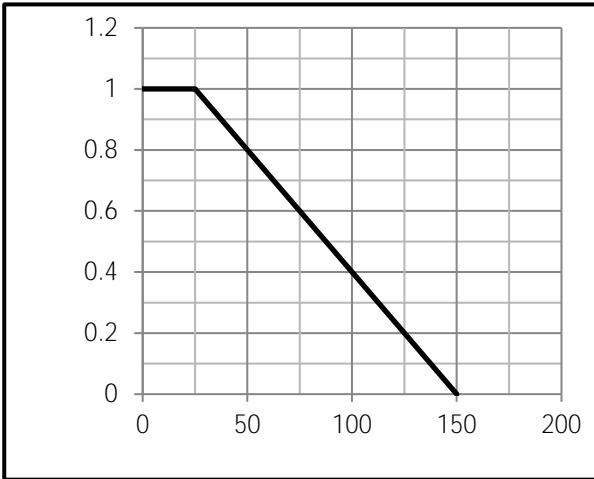

Fig.4

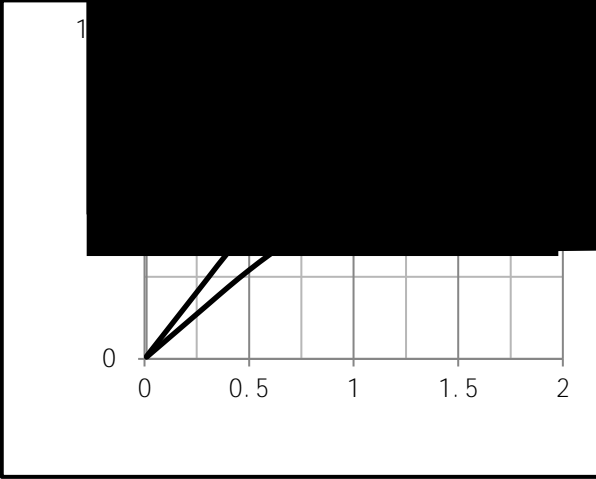

Fig.5 Threshold Voltage V.S Junction Temperature

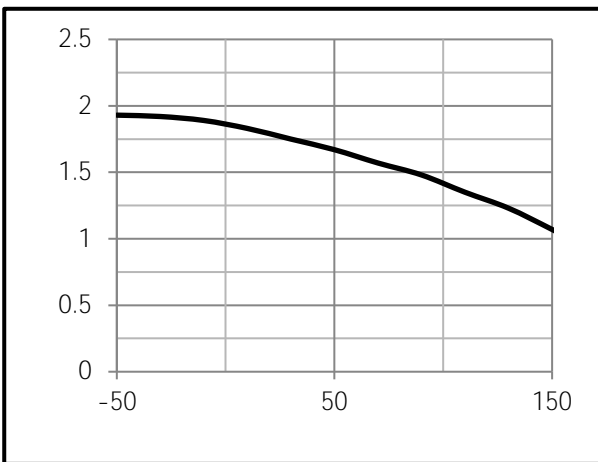

Fig.6 Resistance V.S Drain Current

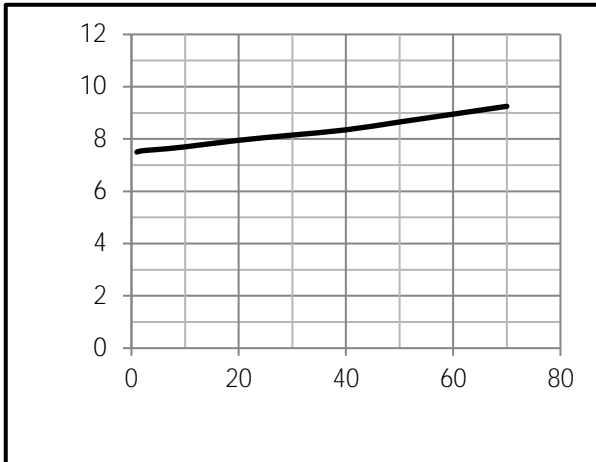



Fig.7 On-Resistance VS Gate Source Voltage

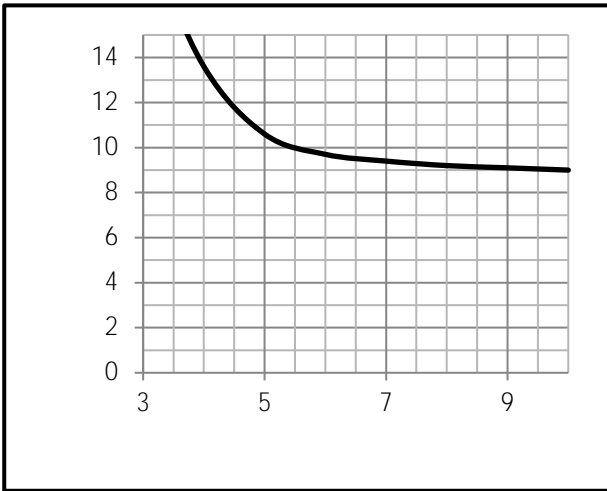

Fig.8 On-Resistance V.S Junction Temperature

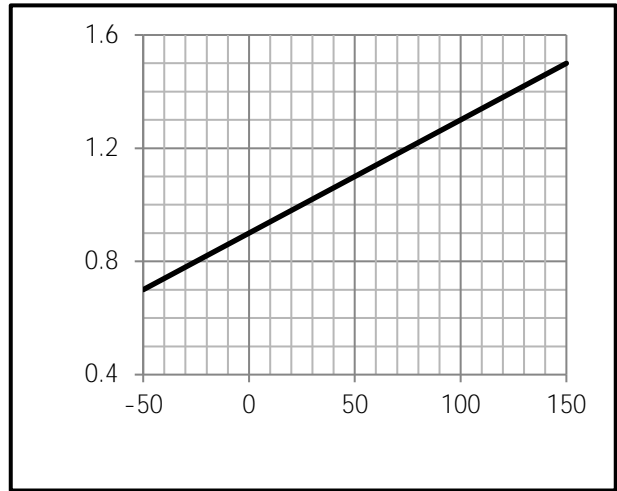

Fig.9 Switching Time Measurement Circuit

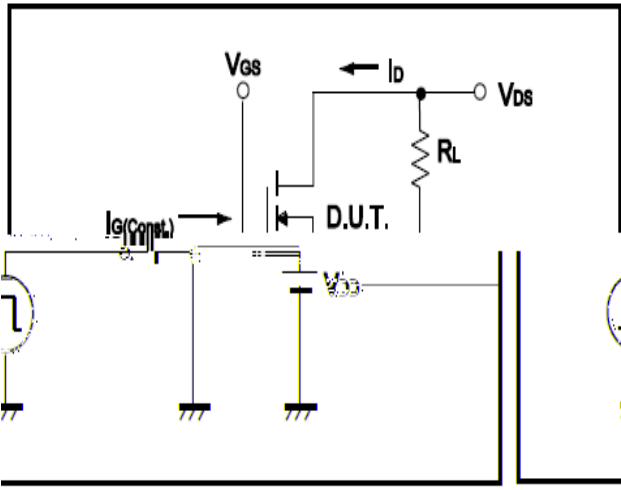

Fig.10 Gate Charge Waveform

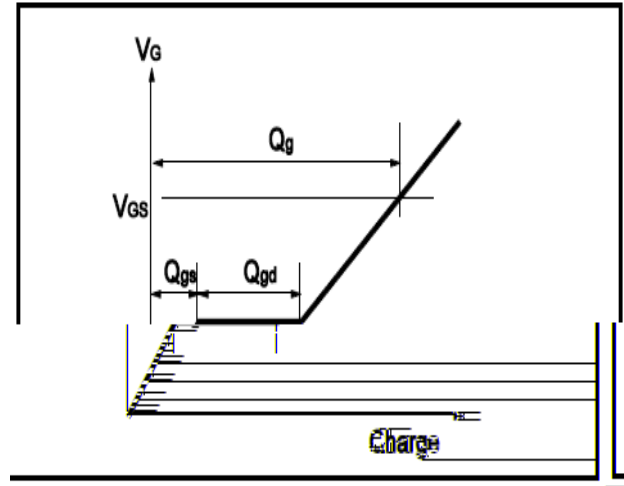

Fig.11 Switching Time Measurement Circuit

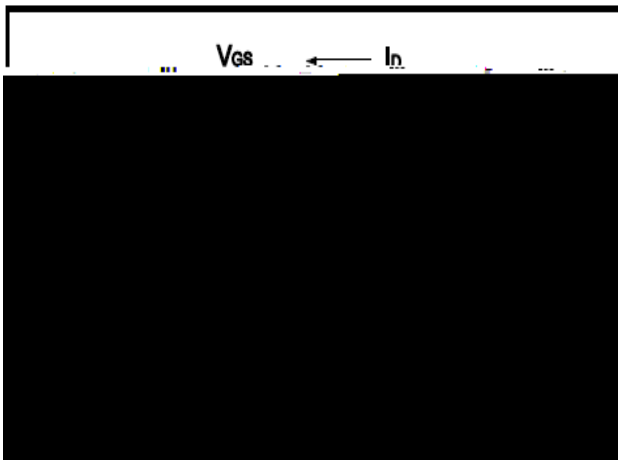
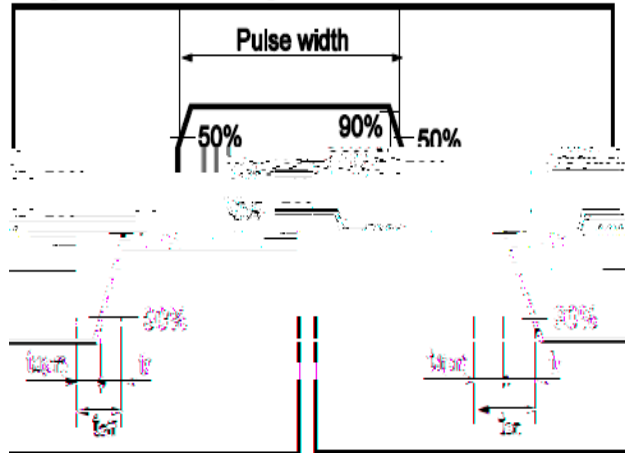

Fig.12 Gate Charge Waveform





sions(DFN3x3)

Unit mm

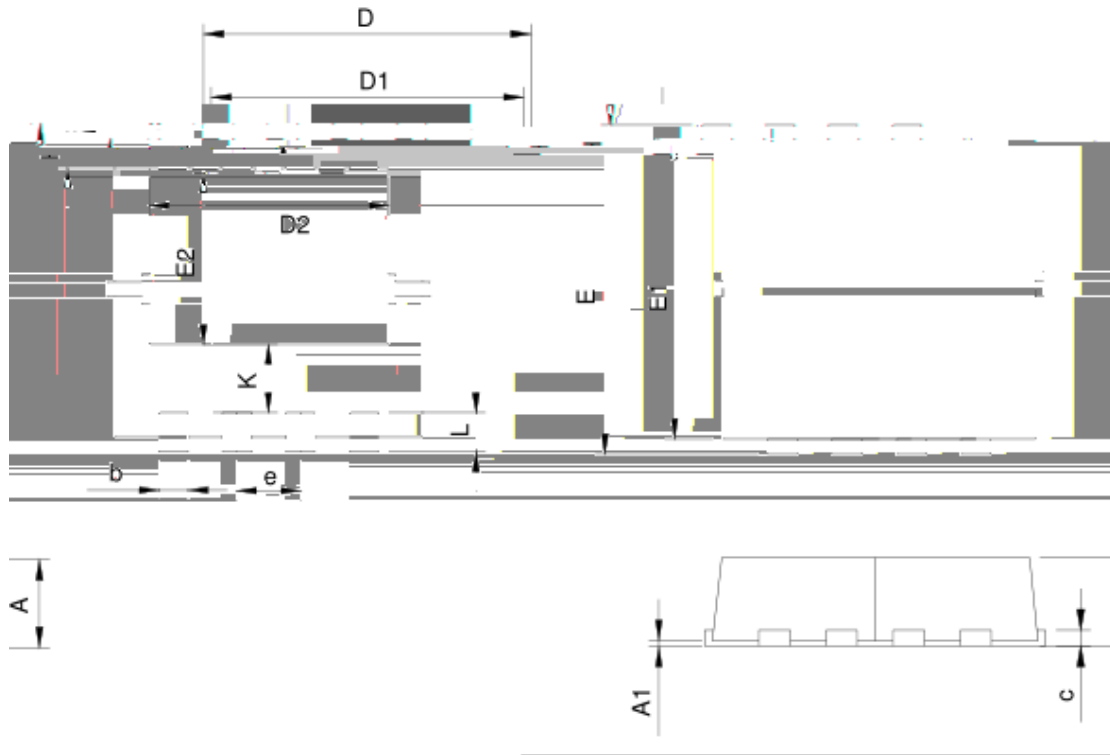

DFN3.3x3.3-8		RECOMMENDED LAND PATTERN			
		MILLIMETERS		INCHES	
		MIN.	MAX.	MIN.	MAX.
A	0.70	1.00	0.028	0.039	
A1	0.00	0.05	0.000	0.002	
b	0.25	0.35	0.010		
c	0.14	0.20	0.006		
D	3.10	3.50	0.122		
D1	3.05	3.25	0.120		
D2	2.35	2.55	0.093	0.100	
E	3.10	3.50	0.122	0.138	
E1	2.90	3.10	0.114	0.122	
E2	2.35	2.55	0.093	0.100	
e	0.65 BSC	0.52	0.013	0.020	
H	0.32	0.52	0.013	0.020	
K	0.59	0.79	0.023	0.031	
	0.25	0.35	0.010	0.022	