

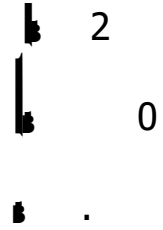

Product Summary

The ZM028N04F combines advanced trench MOSFET technology with a low resistance package to provide extremely low $R_{DS(ON)}$. This device is ideal for load switch and battery protection applications.



Advance high cell density Trench technology $R_{DS(ON)}$ to minimize conductive loss

nd Synchronous Rectifier

$T_C = 25$

Parameter	Symbol	Rating	Unit
Drain-Source Voltage	V_{DS}	45	V
Gate-Source Voltage	V_{GS}	± 20	V
Continuous Drain Current	$I_{D@TC=25}$	80	A
	$I_{D@TC=75}$	60	A
	$I_{D@TC=100}$	50	A
Pulsed Drain Current	I_{DM}	320	A
Total Power Dissipation($TC=25$)	$P_D@TC=25$	75	W
Total Power Dissipation($TA=25$)	$P_D@TA=25$	2	W
Operating Junction Temperature	T_J	-55 to 150	
Storage Temperature	T_{STG}	-55 to 150	
Single Pulse Avalanche Energy	E_{AS}	720	mJ

**Thermal resistance**

Parameter	Symbol	Min.	Typ.	Max.	Unit
Thermal resistance, junction - case	R_{thJC}	-	-	2.8	$^{\circ}C/W$
Thermal resistance, junction - ambient	R_{thJA}	-	-	62	$^{\circ}C/W$
Soldering temperature, wave soldering for 10s	T_{sold}	-	-	265	$^{\circ}C$

Parameter	Symbol	Condition	Min.	Typ.	Max.	Unit
Drain-Source Breakdown Voltage	BV_{DSS}	$V_{GS} = 0V, I_D = 250\mu A$	45			V
Gate Threshold Voltage	$V_{GS(TH)}$	$V_{GS} = V_{DS}, I_D = 250\mu A$	1.2		2.5	V
Drain-Source Leakage Current	I_{DSS}	$V_{DS} = 40V, V_{GS} = 0V$			1.0	μA
Gate- Source Leakage Current	I_{GSS}	$V_{GS} = \pm 20V, V_{DS} = 0V$			100	nA
Static Drain-source On Resistance	$r_{DS(on)}$	$V_{GS} = 10V, I_D = 24A$				Ω



Fig.7 Threshold Voltage V.S Junction Temperature

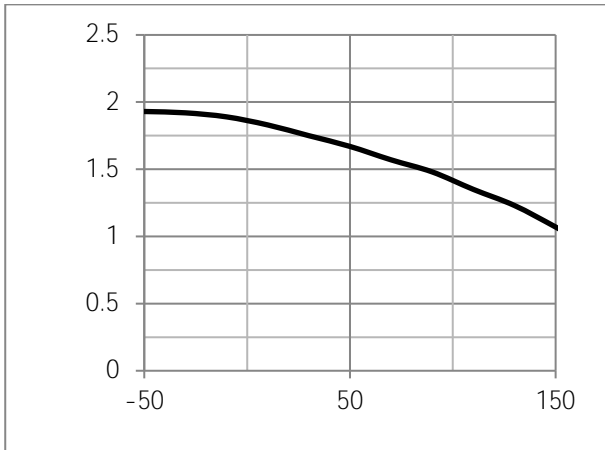

Fig.8 Resistance V.S Drain Current

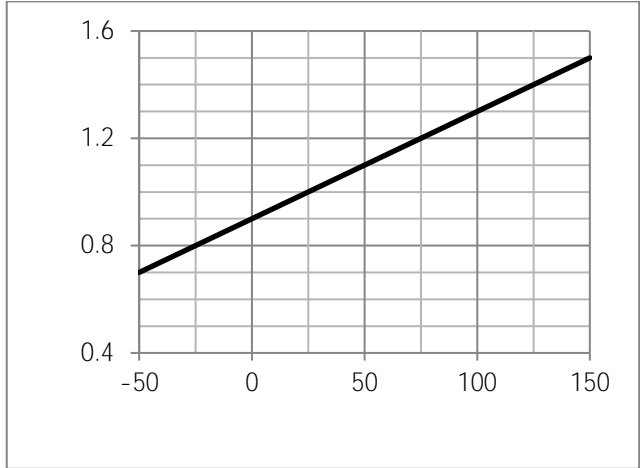
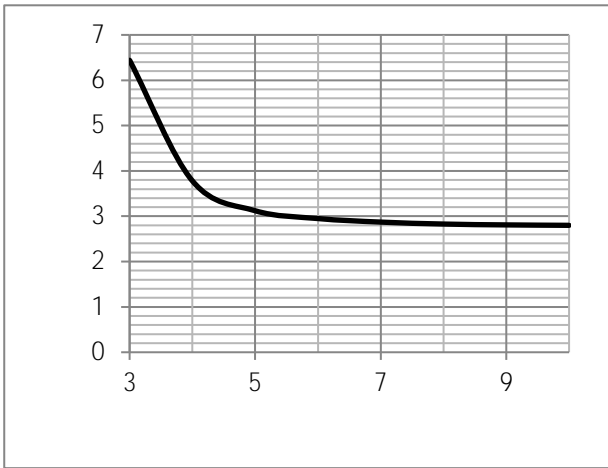
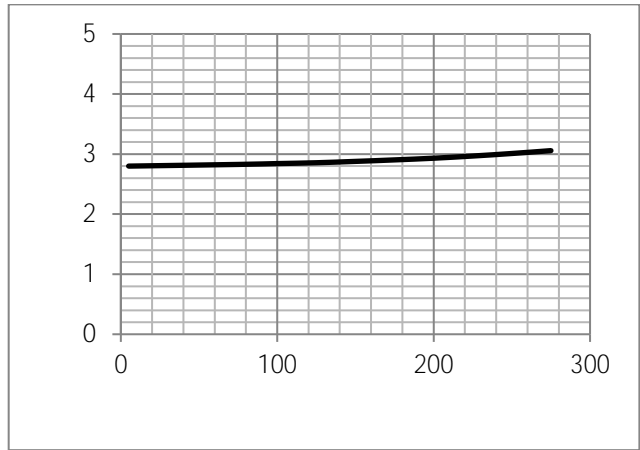

Fig.11 Switching Time Measurement Circuit

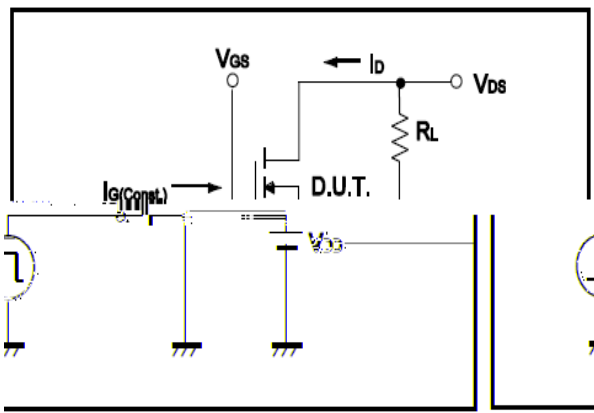

Fig.12 Gate Charge Waveform

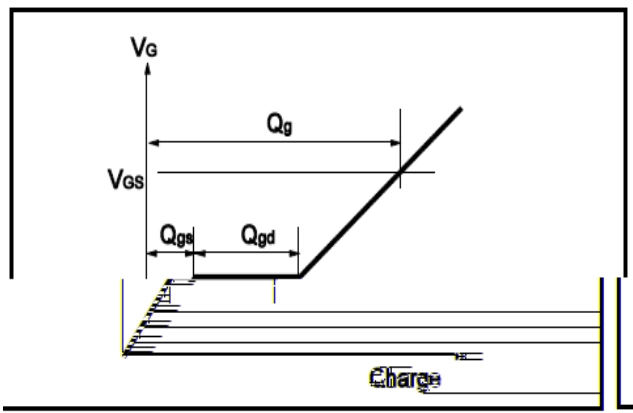



Fig.9 Switching Time Measurement Circuit

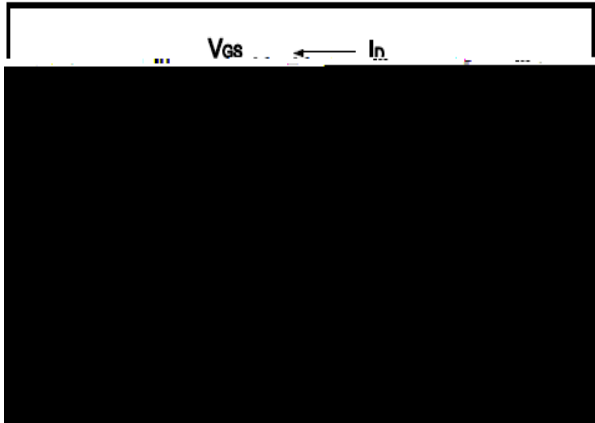

Fig.10 Gate Charge Waveform

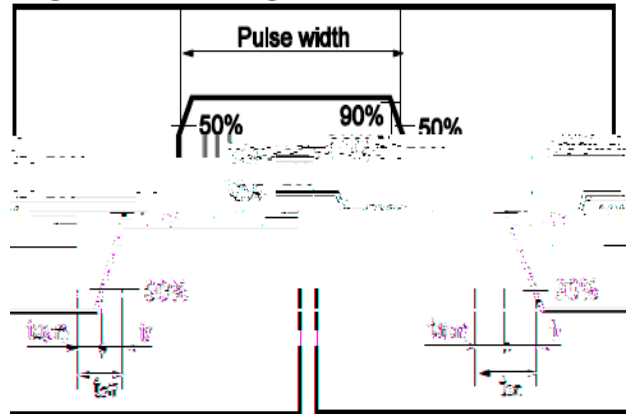

Fig.11 Avalanche Measurement Circuit

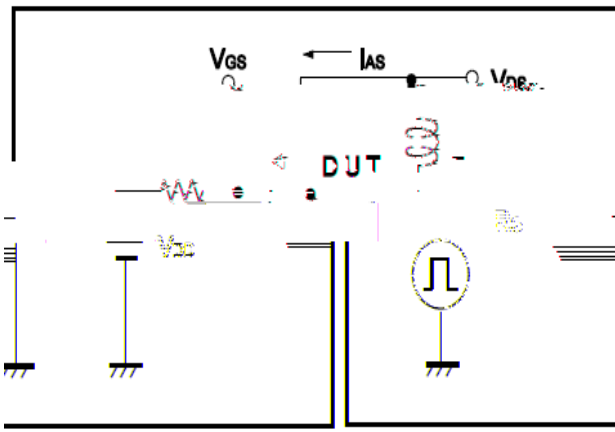
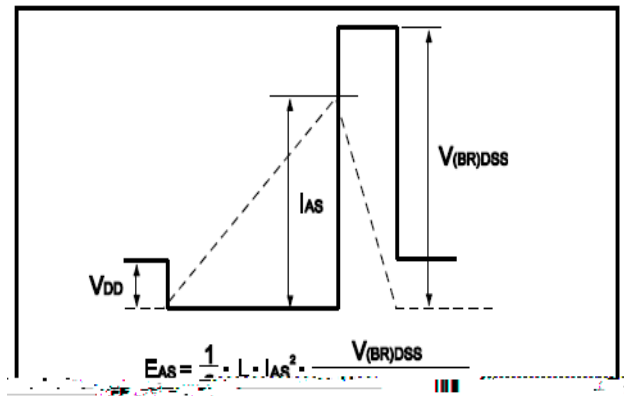

Fig.12 Avalanche Waveform





Dimensions (TO-220F)

Unit mm

SYMBOL	min	nom	max	SYMBOL	min	nom	max
A	4.40		4.95	e		2.54	
A ₁	2.30		2.90	L	12.50		14.30
b	0.45		0.90	L ₁	9.10		10.05
b ₁	1.10		1.70	L ₂	15.00		16.00
c	0.35		0.90	L ₃	3.00		4.00
D	14.50		17.00				