



P Channel characteristics curve

Fig.1 Power Dissipation Derating Curve

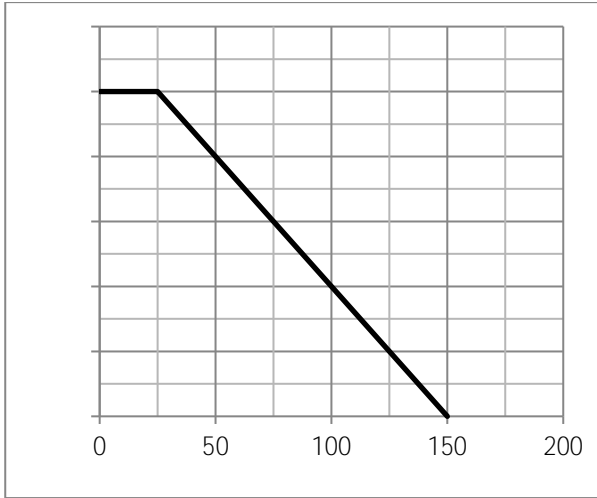

Fig.2 Typical output Characteristics

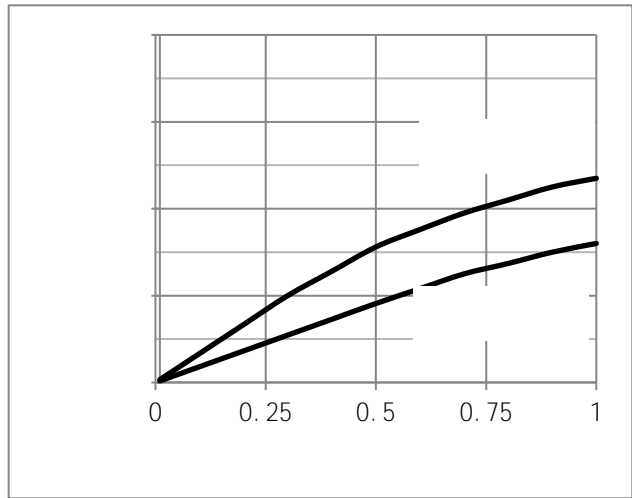

Fig.3 Threshold Voltage V.S Junction Temperature

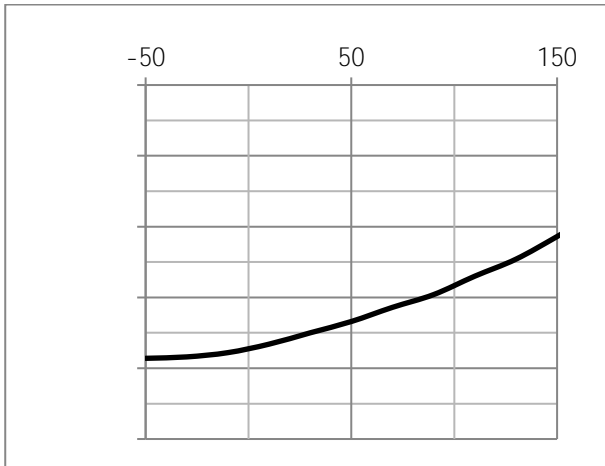
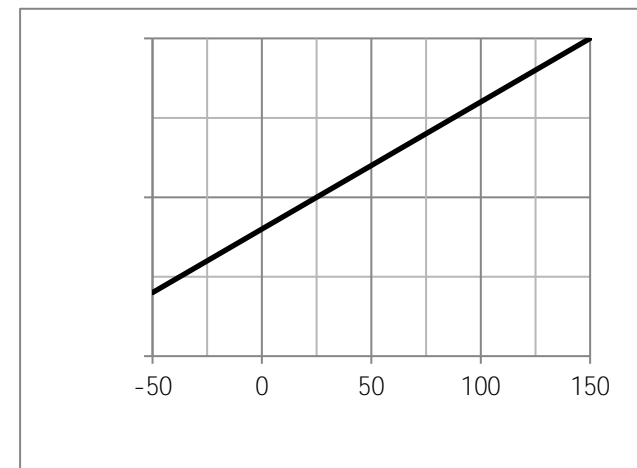
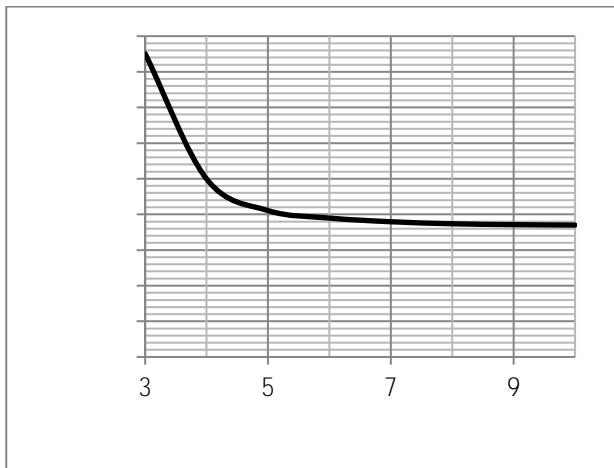
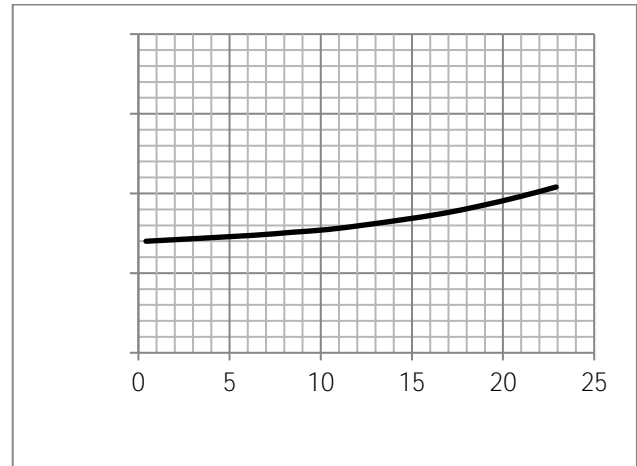

Fig.4 Resistance V.S Drain Current



Test Circuit

Fig.7 Switching Time Measurement Circuit

Fig.8 Gate Charge Waveform

Fig.9 Switching Time Measurement Circuit

Fig.10 Gate Charge Waveform

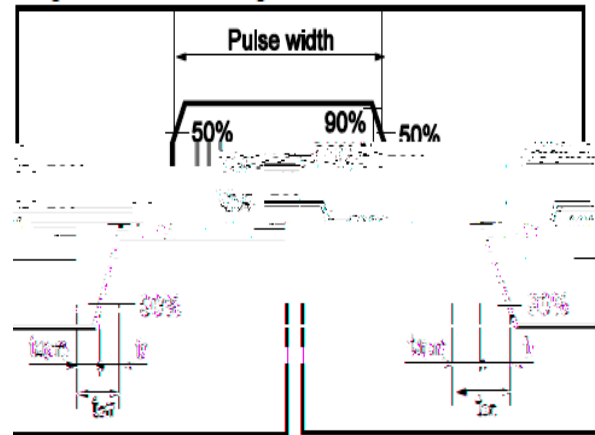
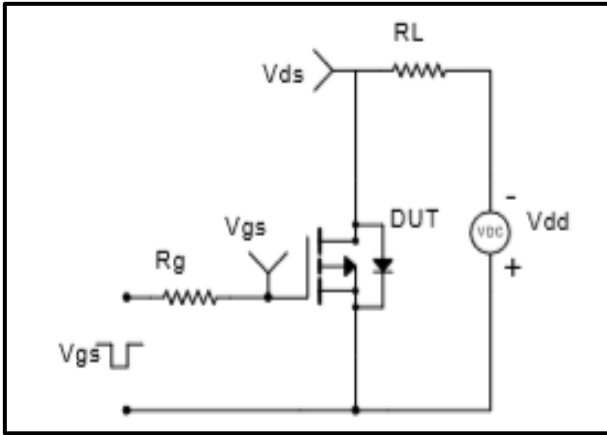

Fig.11 Avalanche Measurement Circuit

Fig.12 Avalanche Waveform

