Avalanche Current	I_{AS} I_{AR}	40	A
-------------------	-------------------	----	---

Thermal resistance

Parameter	Symbol	Min.	Typ.	Max.	Unit
Thermal resistance, junction - case	R_{thJC}	-	-	2.5	° C/W
Thermal resistance, junction - ambient	R_{thJA}	-	-	70	° C/W
Soldering temperature, wavesoldering for 10s	T_{sold}	-	-	265	° C

Electronic Characteristics

Parameter	Symbol	Condition	Min.	Typ	Max.	Unit
Drain-Source Breakdown Voltage	BV_{DSS}	$V_{GS} = 0V, I_D = 250\mu A$	30			V
Gate Threshold Voltage	$V_{GS(TH)}$	$V_{GS} = V_{DS}, I_D = 250\mu A$	1.2		2.5	V
Drain-Source Leakage Current	I_{DSS}	$V_{DS} = 30V, V_{GS} = 0V$			1.0	μA
Gate- Source Leakage Current	I_{GSS}	$V_{GS} = \pm 20V, V_{DS} = 0V$			100	nA
Static Drain-source On Resistance		$V_{GS} = 10V, I_D = 20A$				
		$V_{GS} = 4.5V, I_D = 10A$				
Forward Transconductance	g_{FS}	$V_{DS} = 25V, I_D = 10A$				
Source-drain voltage	V_{SD}	$I_S = 10A$				

Electronic Characteristics

Parameter	Symbol	Condition	Min.	Typ	Max.	Unit
Input capacitance	C_{iss}	$f = 1MHz$	-	1150	-	μF
Output capacitance	C_{oss}		-	230	-	
Reverse transfer capacitance	C_{rss}		-	113	-	

Gate Charge characteristics($T_a = 25$)

Parameter	Symbol	Condition	Min.	Typ	Max.	Unit
Total gate charge	Q_g	$V_{DD} = 25V$	-	12	-	nC
Gate - Source charge	Q_{gs}	$I_D = 5A$	-	4	-	
Gate - Drain charge	Q_{gd}	$V_{GS} = 10V$	-	6	-	

Note:

;

Fig.1 Power Dissipation

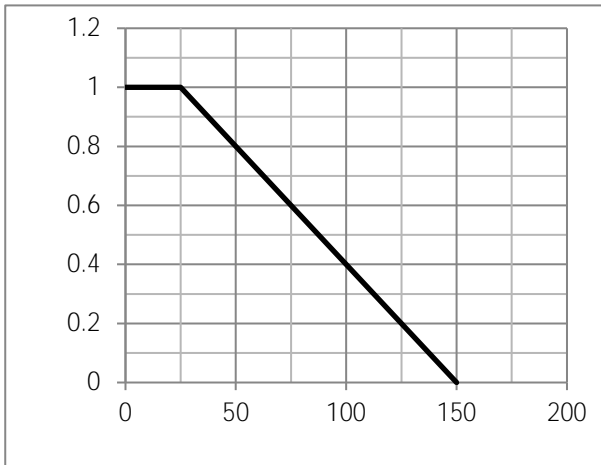

Fig.2 Typical output Characteristics

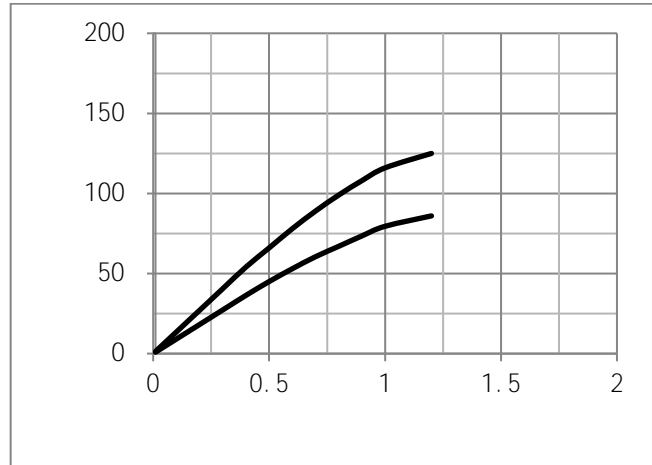

Fig.3 Threshold Voltage V.S Junction Temperature

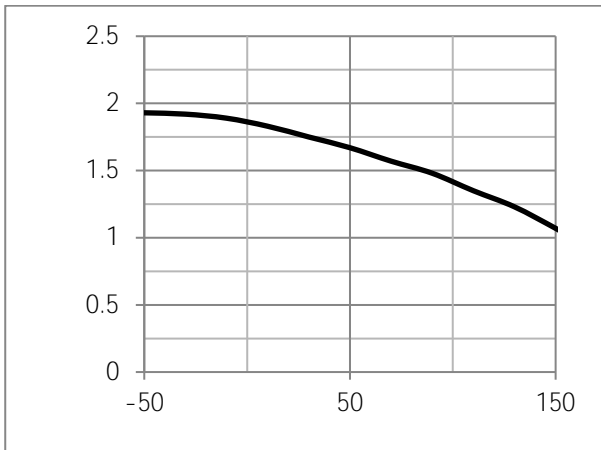

Fig.4 Resistance V.S Drain Current

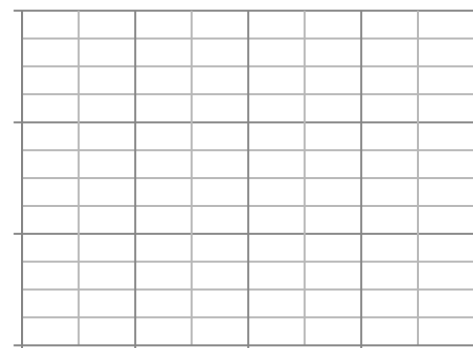
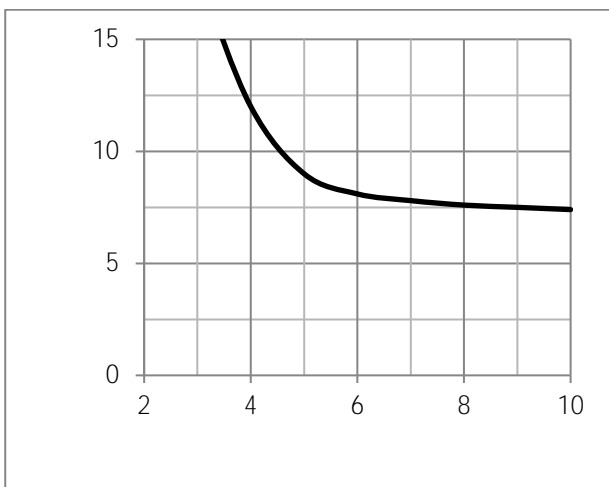
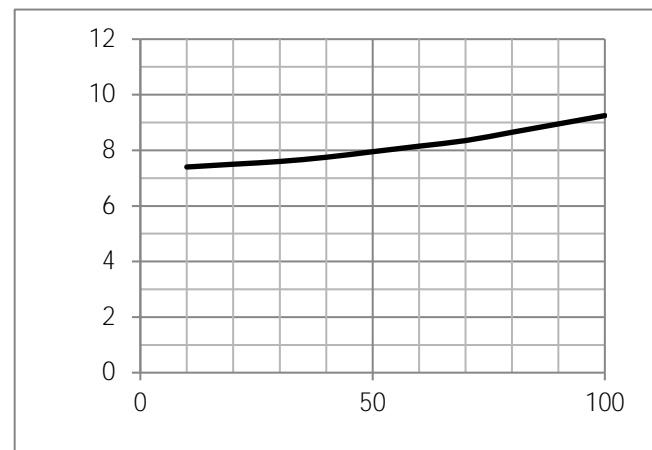

Fig.7 Switching Time Measurement Circuit

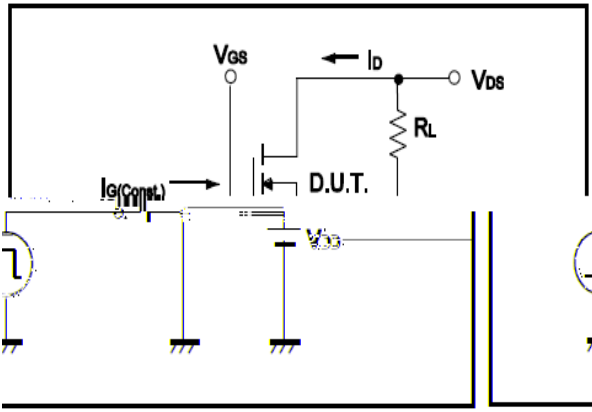

Fig.8 Gate Charge Waveform

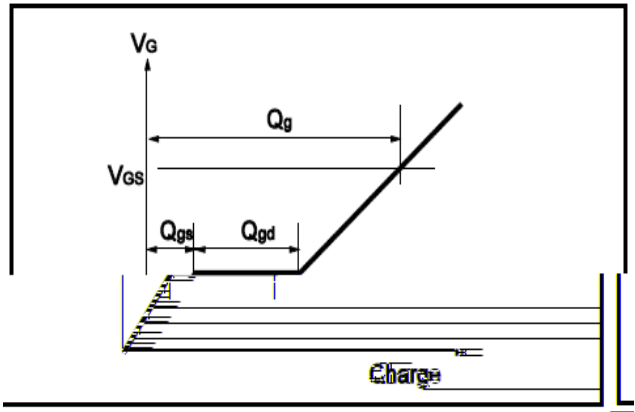

Fig.9 Switching Time Measurement Circuit

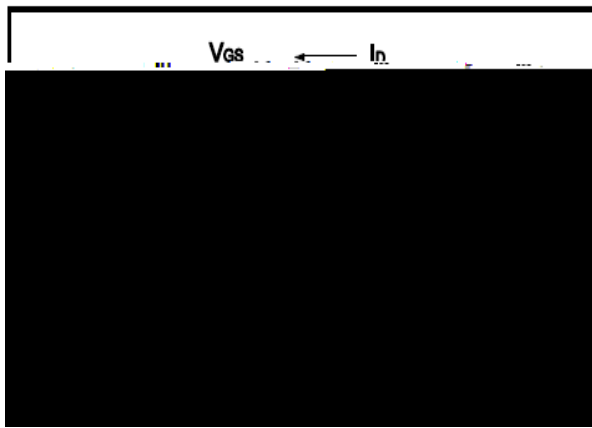

Fig.10 Gate Charge Waveform

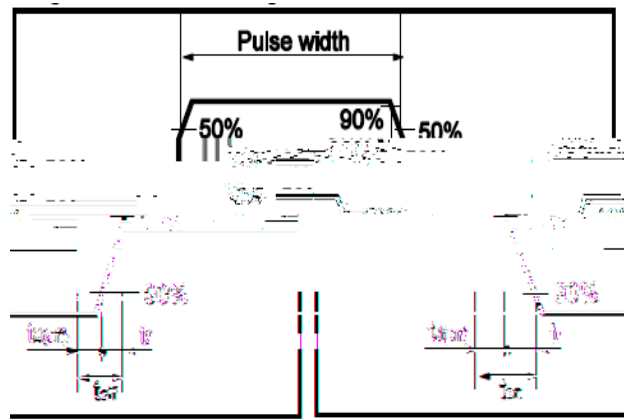

Fig.11 Avalanche Measurement Circuit

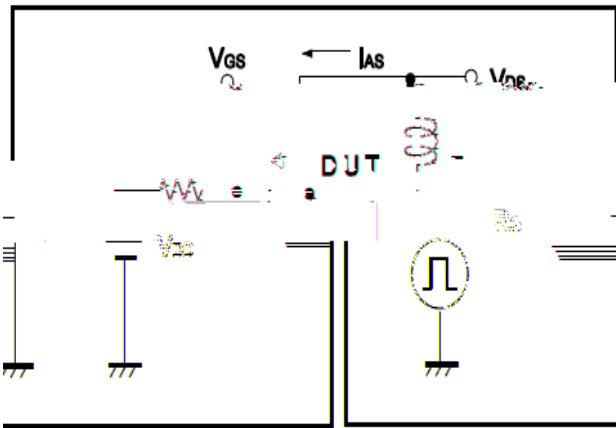
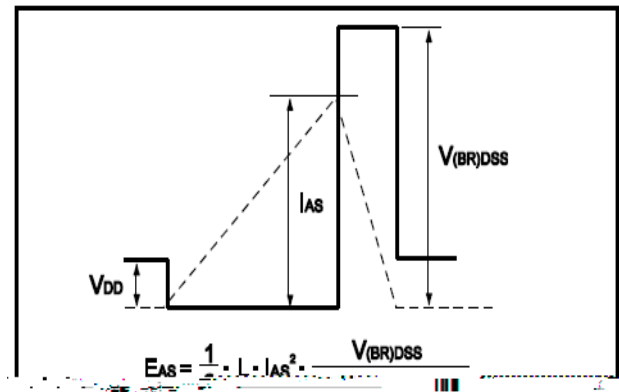

Fig.12 Avalanche Waveform



Dimensions(SOP8)

Unit: mm

SYMBOL	min	TYP	max	SYMBOL	min		max
A	4.80		5.25	C	1.30		1.75
A1	0.37		0.49	C1	0.55		0.75
A2		1.27		C2	0.55		0.65
A3		0.41		C3	0.05		0.20
B	5.80		6.20	C4	0.10	0.20	0.23
B1	3.80		4.10	D		1.05	
B2		5.00		D1	0.40		0.62

