

Fig.1 Power Dissipation

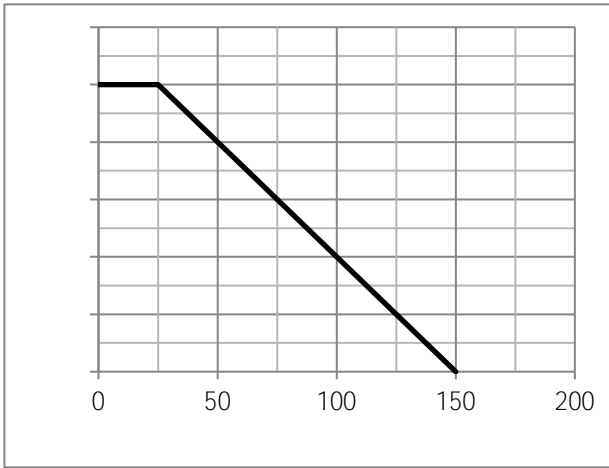

Fig.2 Typical output Characteristics!

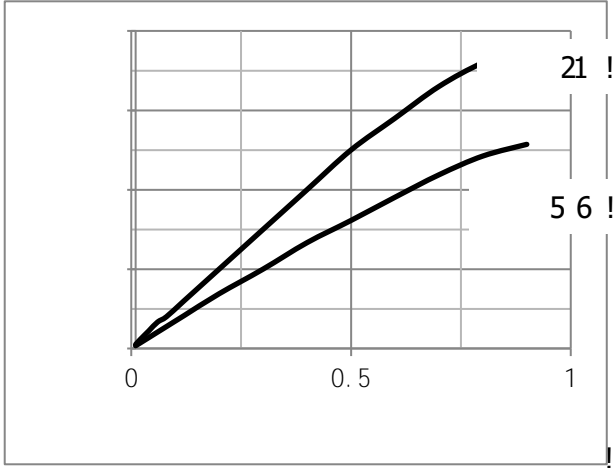

Fig.3 Threshold Voltage V.S Junction Temperature

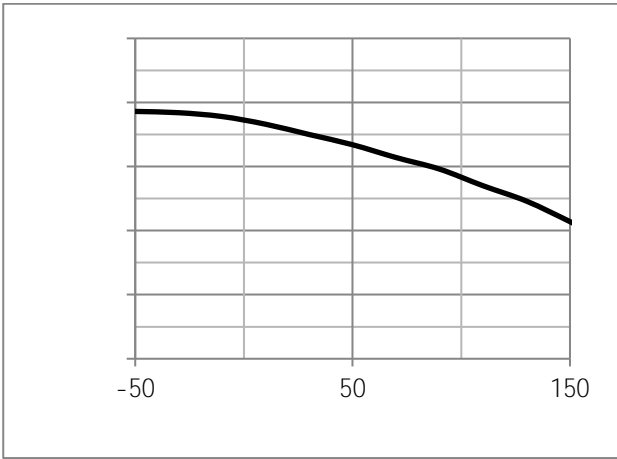
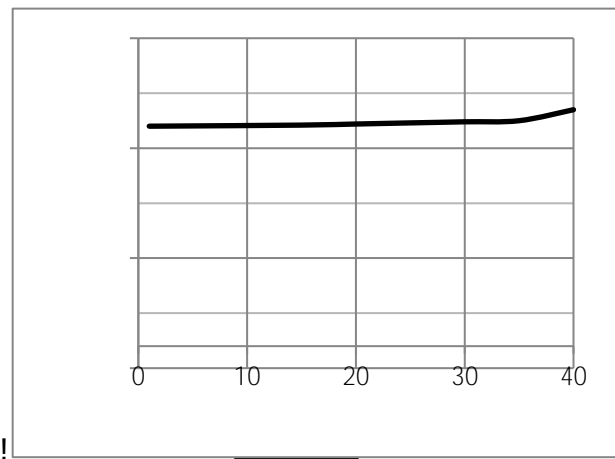

Fig.4 Resistance V.S Drain Current



G 6P 5

!!!!!!G 1P 5

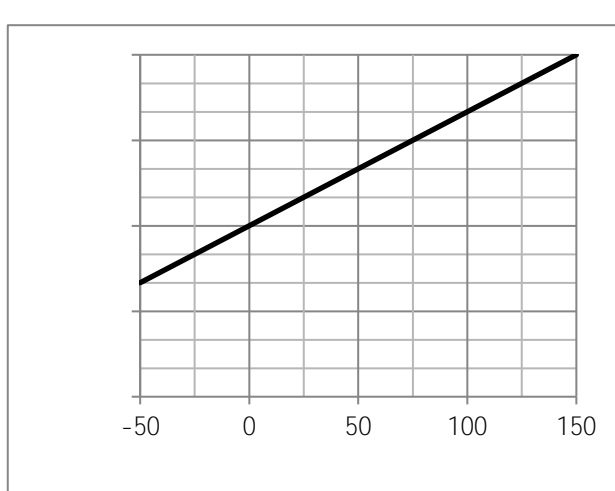
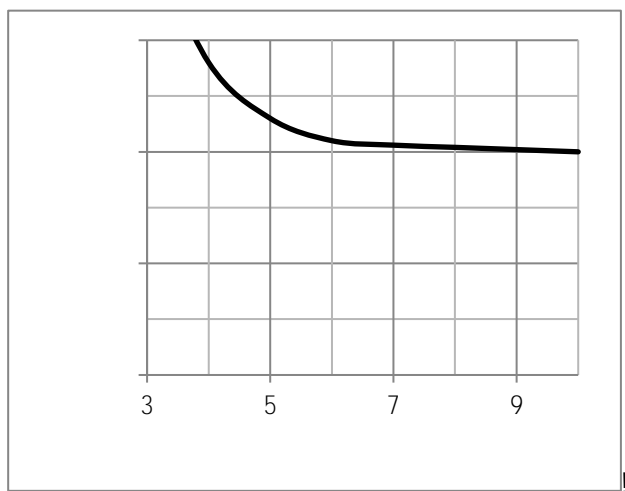

Fig.7 Switching Time Measurement Circuit

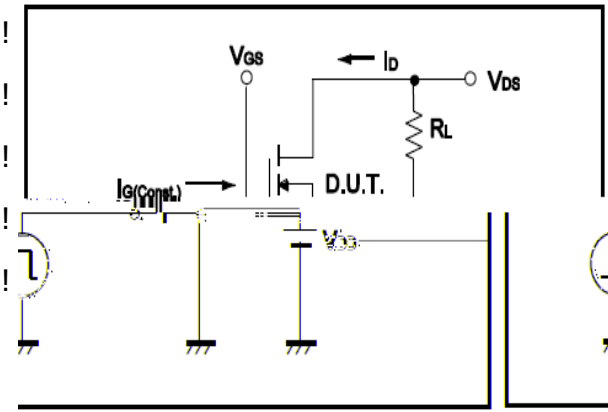

Fig.8 Gate Charge Waveform!!

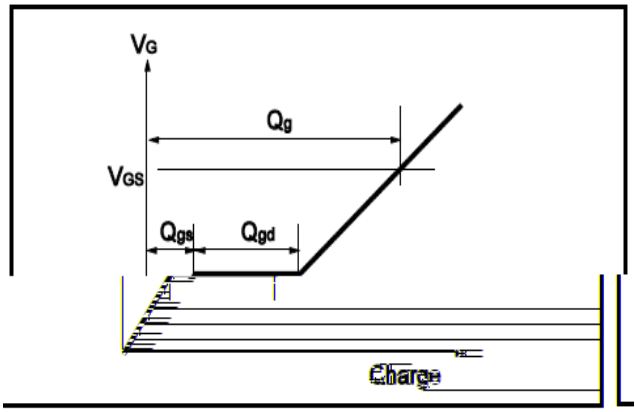

Fig.9 Switching Time Measurement Circuit

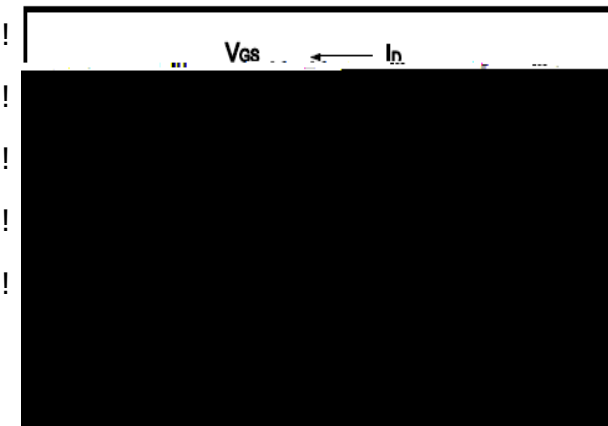

Fig.10 Gate Charge Waveform !

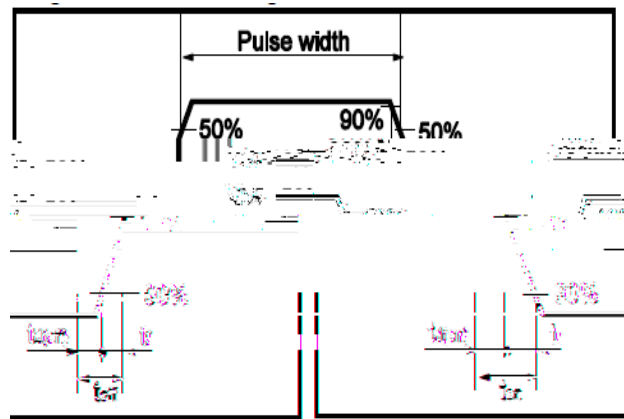

Fig.11 Avalanche Measurement Circuit

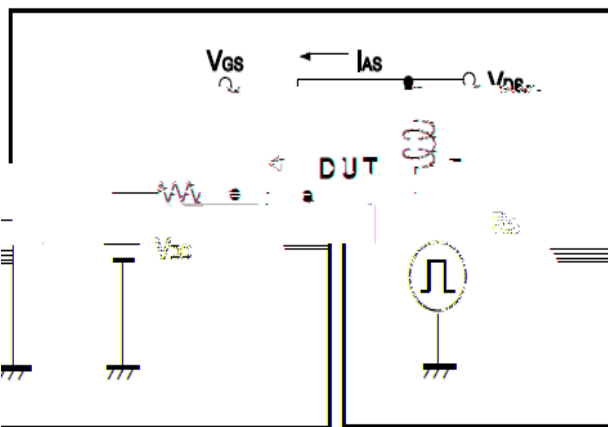
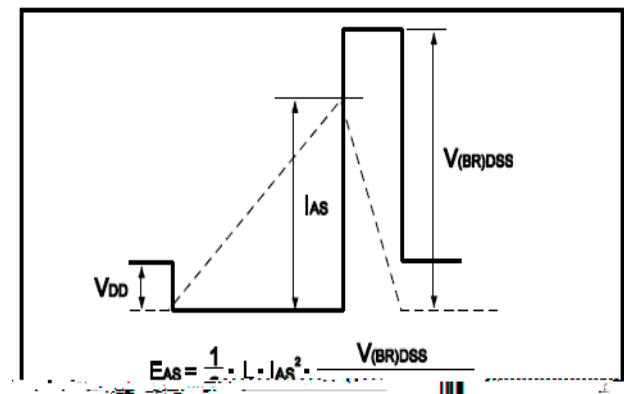

Fig.12 Avalanche Waveform!!



(SOP8)

Unit: mm

SYMBOL	min	TYP	max	SYMBOL	min		max
A	4.80		5.25	C	1.30		1.75
A1	0.37		0.49	C1	0.55		0.75
A2		1.27		C2	0.55		0.65
A3		0.41		C3	0.05		0.20
B	5.80		6.20	C4	0.10	0.20	0.23
B1	3.80		4.10	D		1.05	
B2		5.00		D1	0.40		0.62

