

Thermal resistance

Parameter	Symbol	Min.	Typ.	Max.	Unit
Thermal resistance, junction - case	R _{thJC}	-	-	2.1	° C/W
Thermal resistance, junction - ambient	R _{thJA}	-	-	62.5	° C/W
Soldering temperature, wavesoldering for 10s	T _{sold}	-	-	265	° C

I G

Parameter	Symbol	Condition	Min.	Typ	Max.	Unit
Drain-Source Breakdown Voltage	BV _{DSS}	V _{GS} = 0V, I _D = 250uA	100			V
Gate Threshold Voltage	V _{GS(TH)}	V _{GS} = V _{DS} , I _D = 250uA	1.2		2.5	V
Drain-Source Leakage Current	I _{DSS}	V _{DS} = 100V, V _{GS} = 0V			1.0	uA
Gate- Source Leakage Current	I _{GSS}	V _{GS} = ±20V, V _{DS} = 0V			100	nA
Static Drain-source On Resistance		V _{GS} = 10V, I _D = 30A				
		V _{GS} = 4.5V, I _D = 20A				
Forward Transconductance	g _{FS}	V _{DS} = 25V, I _D = 10A				
Diode Forward Voltage	V _{FSD}	I _S = 30A				

I G

Parameter	Symbol	Condition	Min.	Typ	Max.	Unit
Input capacitance	C _{iss}	f = 1MHz	-	2120	-	pF
Output capacitance	C _{oss}		-	940	-	
Reverse transfer capacitance	C _{rss}		-	48	-	

Gate Charge characteristics (T_a = 25)

Parameter	Symbol	Condition	Min.	Typ	Max.	Unit
Total gate charge	Q _g	V _{DD} = 25V	-	28	-	nC
Gate - Source charge	Q _{gs}	I _D = 8A	-	3.8	-	
Gate - Drain charge	Q _{gd}	V _{GS} = 10V	-	5.9	-	

Note:

;

Fig.1 Gate-Charge Characteristics

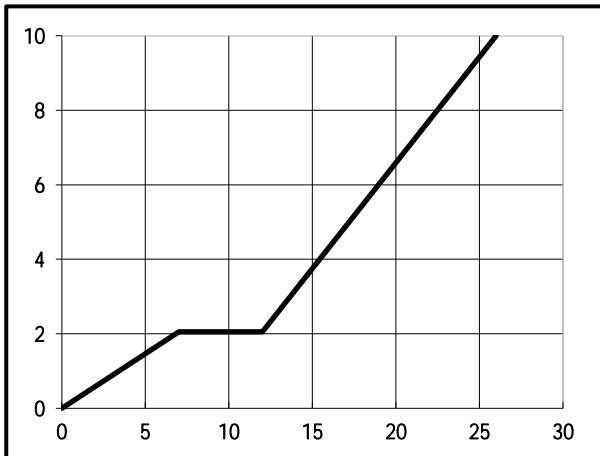

Fig.2 Capacitance Characteristics



Fig.3 Power Dissipation

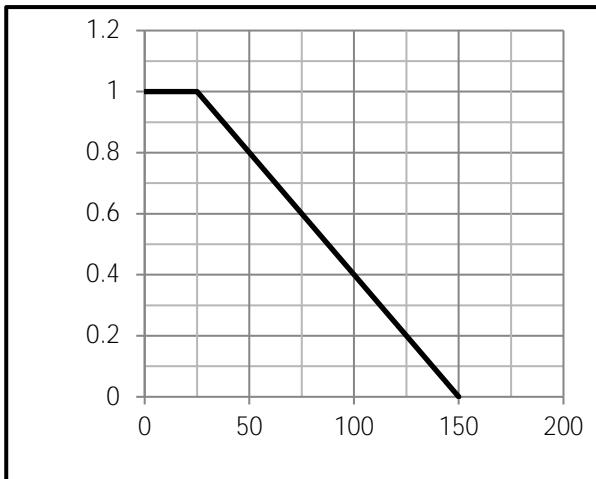

Fig.4 Typical output Characteristics

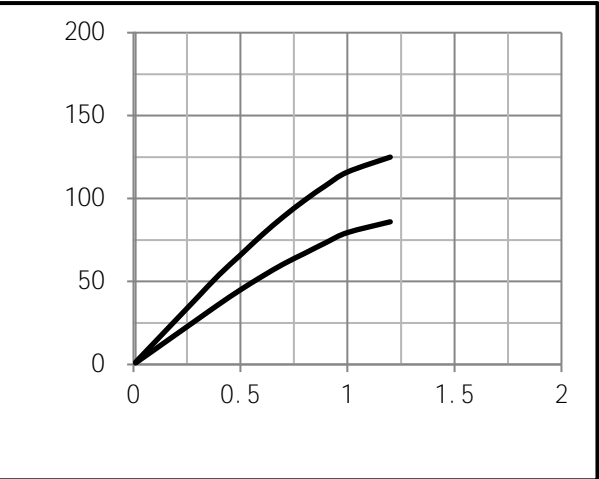

Fig.5 Threshold Voltage V.S Junction Temperature

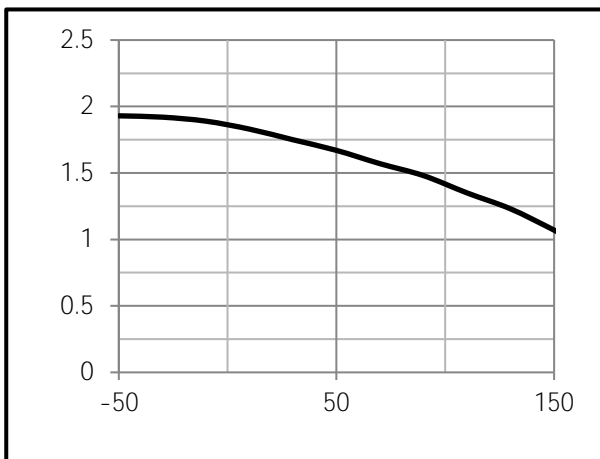
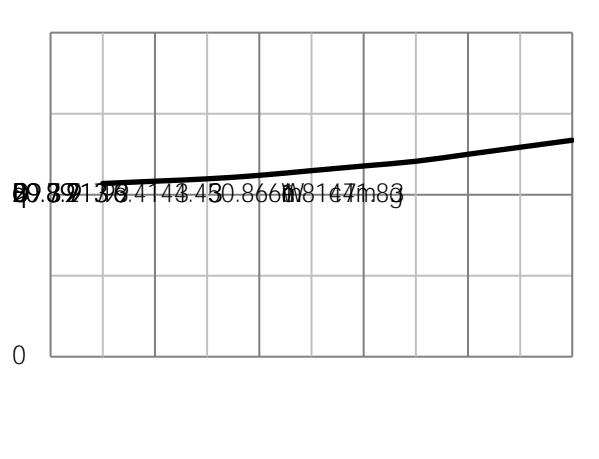

Fig.6 Resistance V.S Drain Current



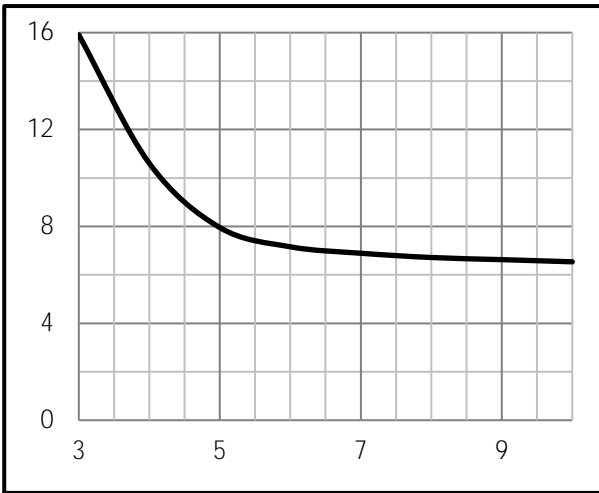

Fig.9 Switching Time Measurement Circuit

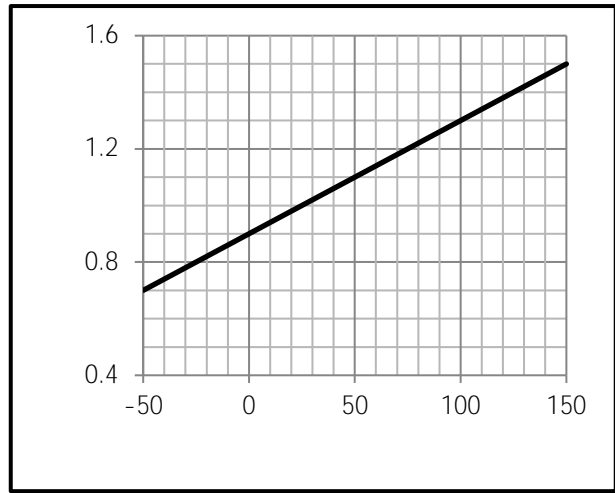

Fig.10 Gate Charge Waveform

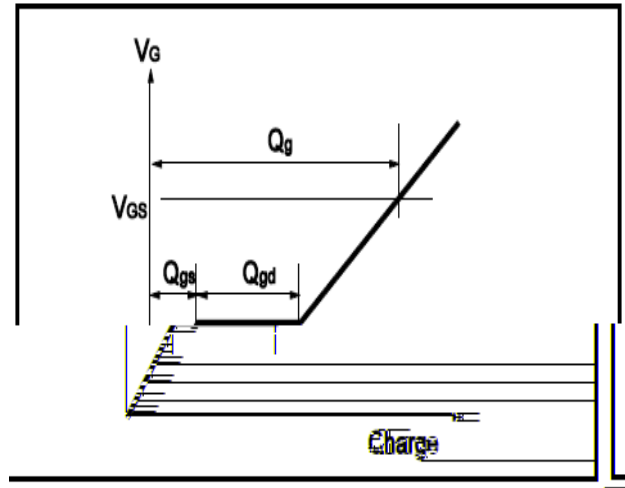
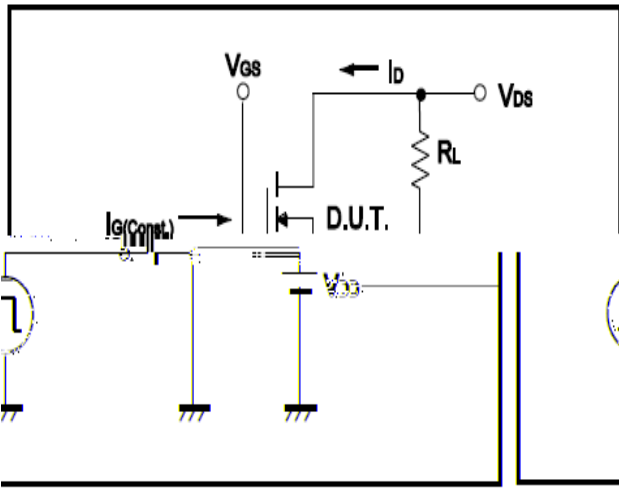

Fig.11 Switching Time Measurement Circuit

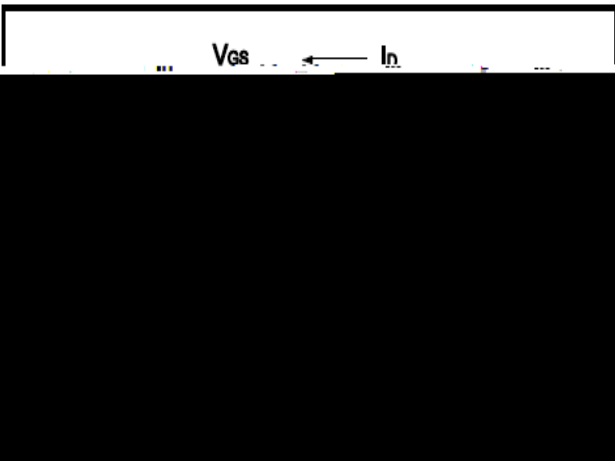
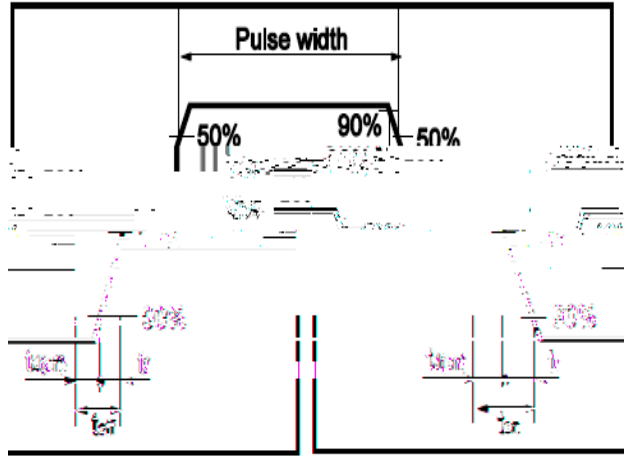

Fig.12 Gate Charge Waveform



Dimensions (TO-252)

Unit mm

SYMBOL	min	max	SYMBOL	min	max
A	2.10	2.50	B	0.85	1.25
b	0.50	0.80	b1	0.50	0.90
b2	0.45	0.70	C	0.45	0.70
D	6.30	6.75	D1	5.10	5.50
E	5.30	6.30	e1	2.25	2.35
L1	9.20	10.60	e2	4.45	4.75
L2	0.90	1.75	L3	0.60	1.10
K	0.00	0.23			

