



Thermal resistance

Parameter	Symbol	Min.	Typ.	Max.	Unit
Thermal resistance, junction - case	R_{thJC}	-	-	56	∇ C/W
Thermal resistance, junction - ambient	R_{thJA}	-	-	180	∇ C/W
Soldering temperature, wavesoldering for 10s	T_{sold}	-	-	265	



Pulsed Drain Current	I_{DM}	18	A
Total Power Dissipation	$P_D@T_C=25$	2.2	W
Total Power Dissipation	$P_D@T_A=25$	0.69	W
Operating Junction Temperature	T_J	-55 to 150	
Storage Temperature	T_{STG}	-55 to 150	
Single Pulse Avalanche Energy	E_{AS}	35	mJ

P Channel Absolute Maximum Ratings



Input capacitance	Ciss	f = 1MHz V _{DS} =25V	-	1150	-	pF
Output capacitance	Coss		-	290	-	
Reverse transfer capacitance	Crss		-			

N Channel characteristics curve

Fig.1 Power Dissipation Derating Curve

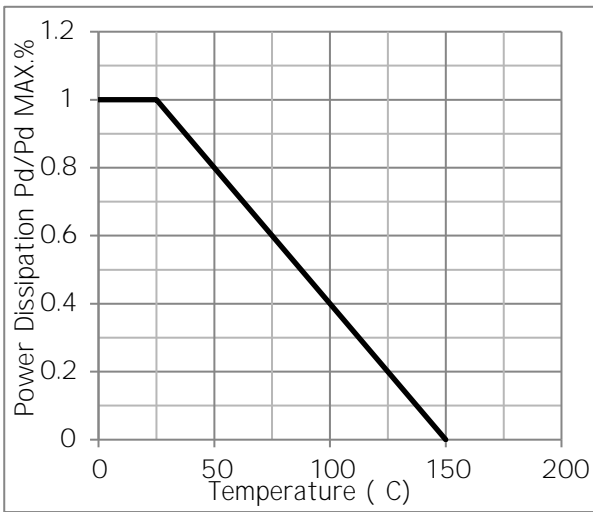

Fig.2 Typical output Characteristics

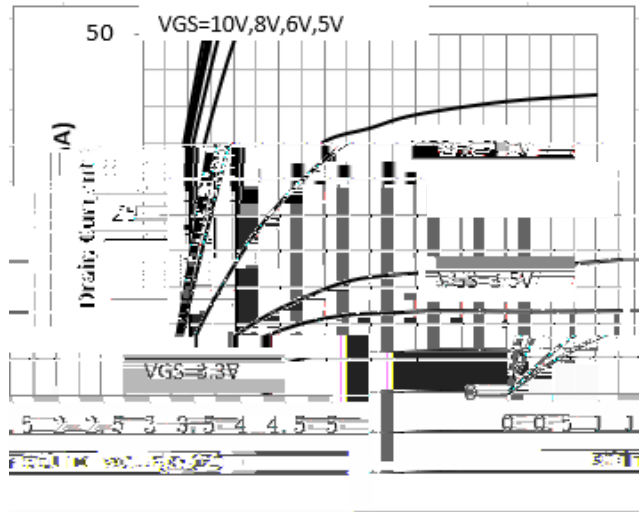

Fig.3 Threshold Voltage V.S Junction Temperature

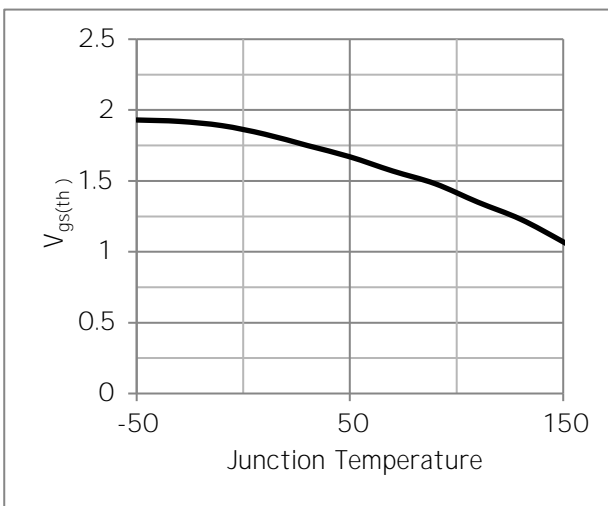

Fig.4 Resistance V.S Drain Current

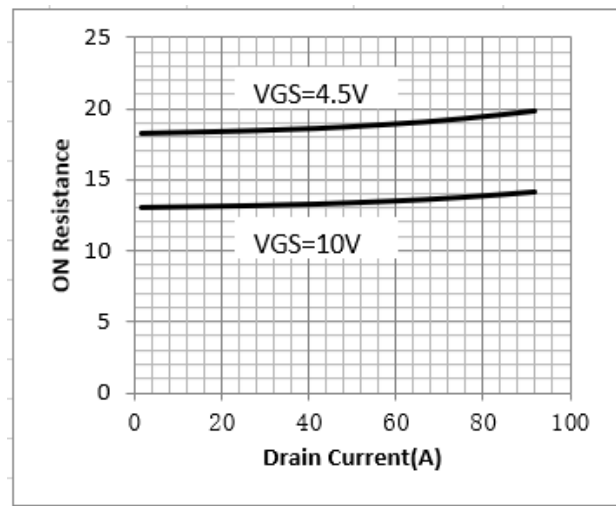

Fig.5 On-Resistance VS Gate Source Voltage

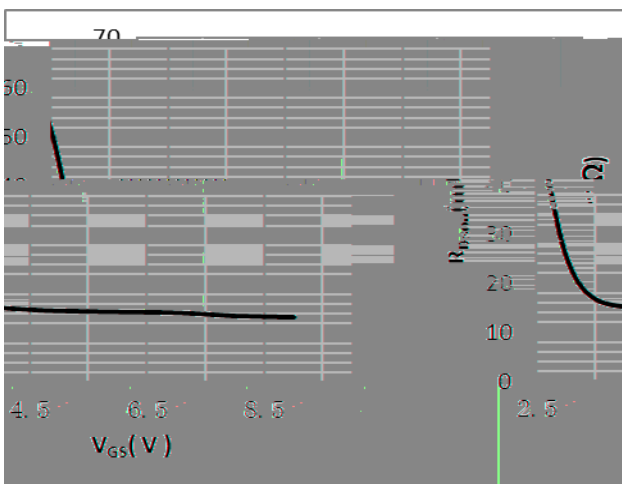
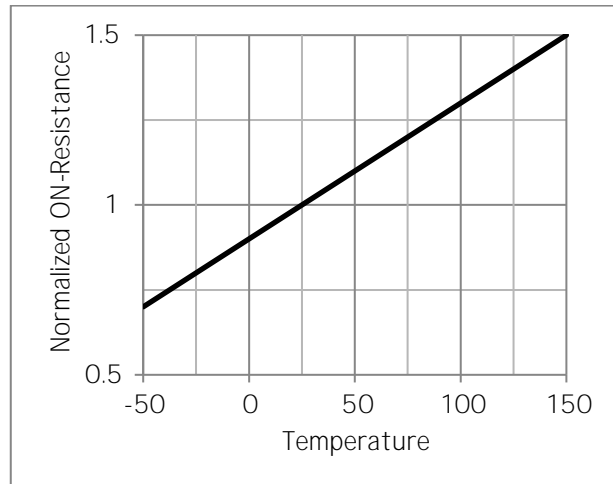

Fig.6 On-Resistance V.S Junction Temperature



P Channel characteristics curve

Fig.1 Power Dissipation Derating Curve

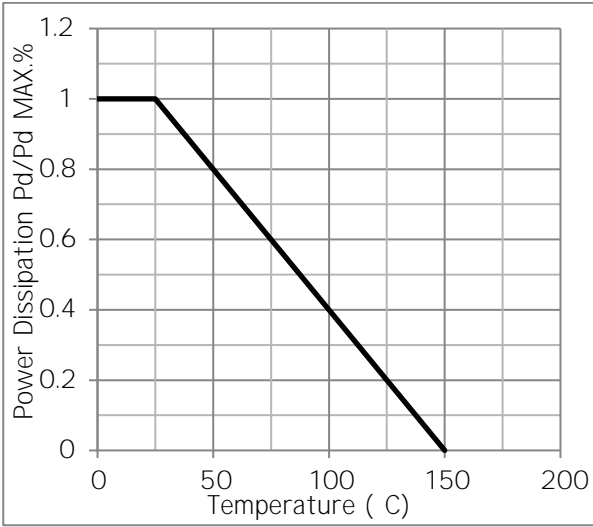

Fig.2 Typical output Characteristics

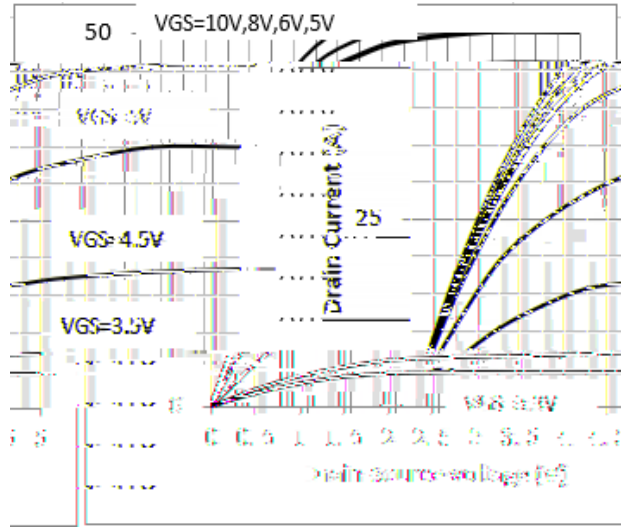

Fig.3 Threshold Voltage V.S Junction Temperature

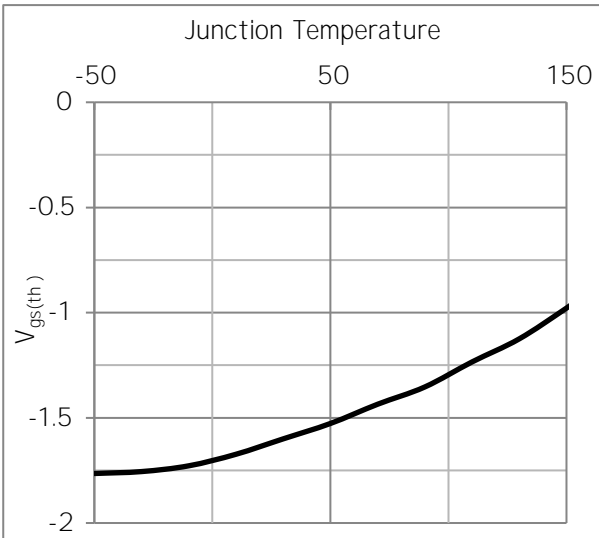

Fig.4 Resistance V.S Drain Current

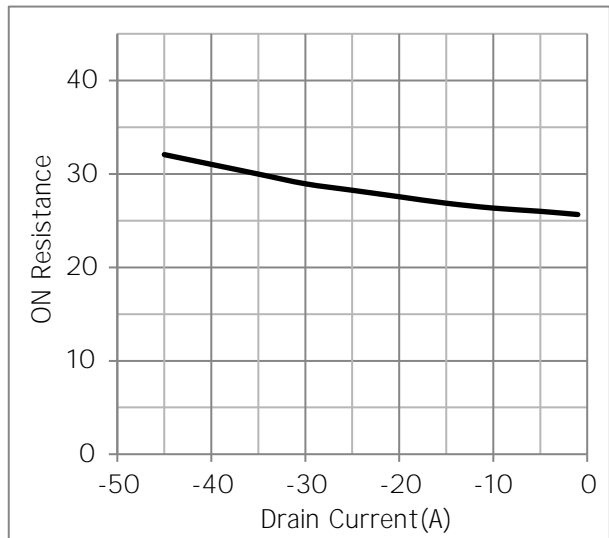

Fig.5 On-Resistance VS Gate Source Voltage

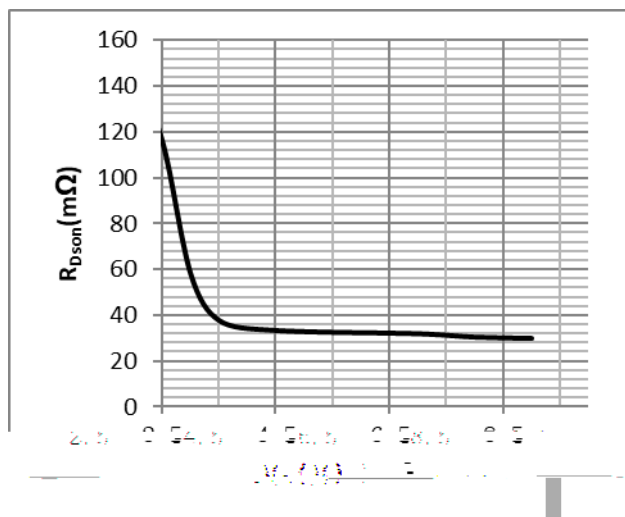
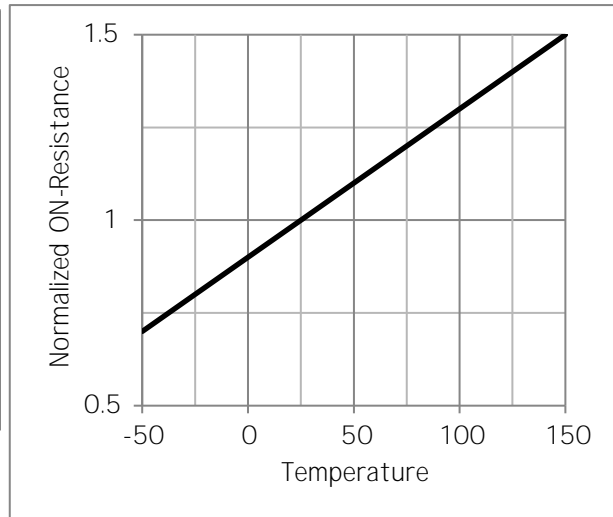

Fig.6 On-Resistance V.S Junction Temperature



Test Circuit

Fig.1 Switching Time Measurement Circuit

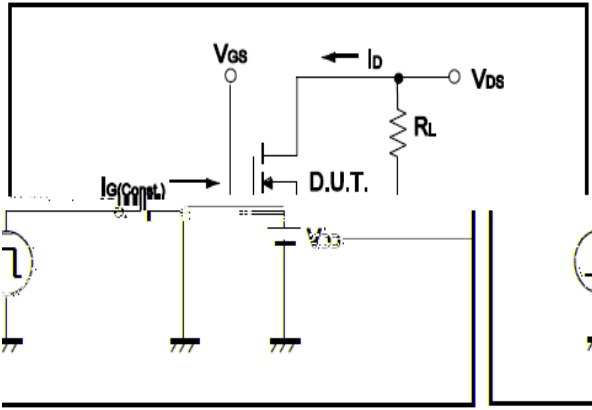

Fig.2 Gate Charge Waveform

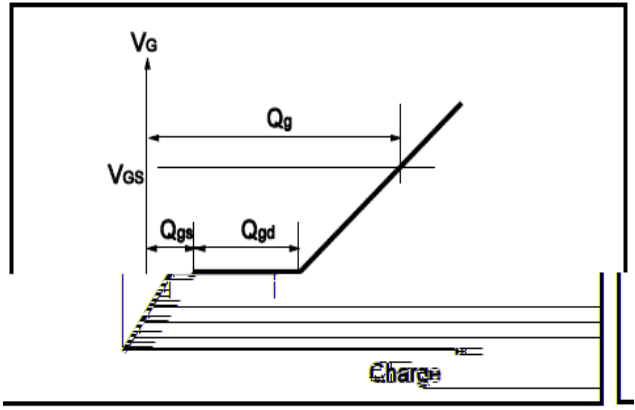

Fig.3 Switching Time Measurement Circuit

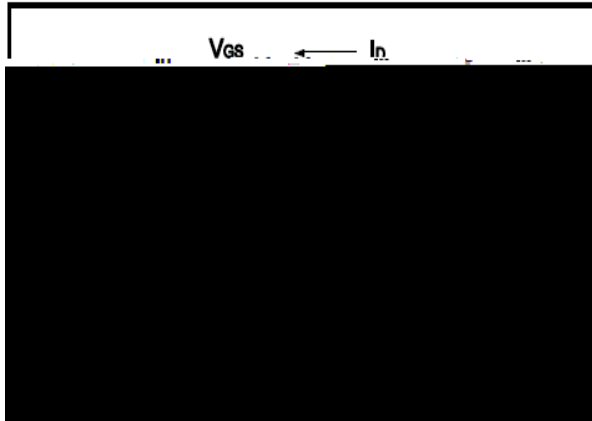

Fig.4 Gate Charge Waveform

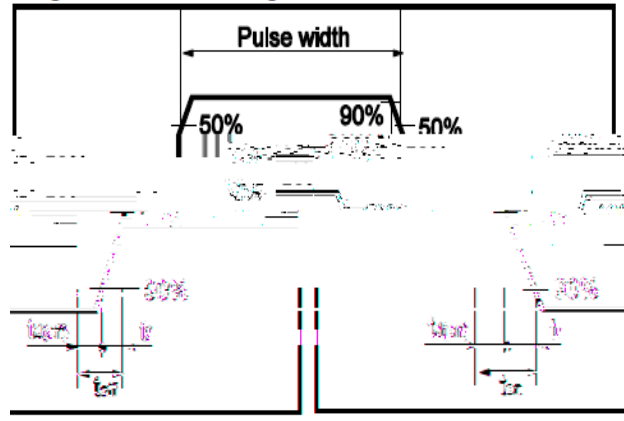

Fig.5 Avalanche Measurement Circuit

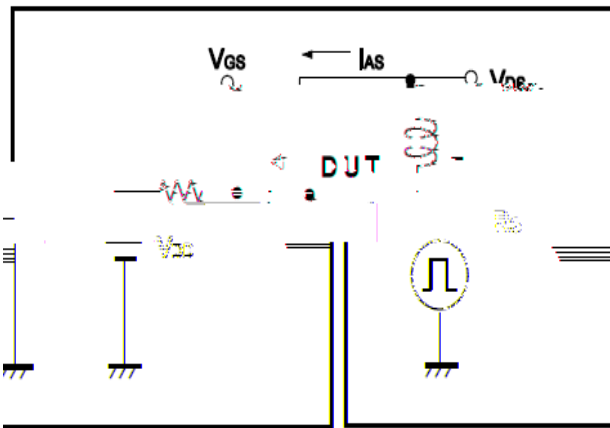

Fig.6 Avalanche Waveform

