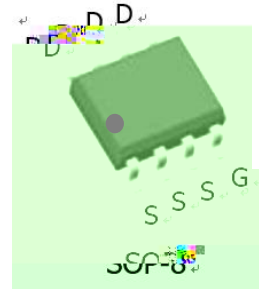

B

It combines advanced trench MOSFET technology with a low resistance package to provide extremely low $R_{DS(ON)}$.

Trench technology
 $R_{DS(ON)}$ to minimize conductive loss

2nd Synchronous Rectifier
 Switching application

D
Product Summary

Part NO.	ZM065N08HS
Marking	ZM065N08H
Packing Information	TAPE
Basic ordering unit (pcs)	4000

 $T_C = 25$

Parameter	Symbol	Rating	Unit
Drain-Source Voltage	V_{DS}	80	V
Gate-Source Voltage	V_{GS}	± 20	V
Continuous Drain Current	$I_D @ T_C = 25$	16	A
	$I_D @ T_C = 75$	12	A
	$I_D @ T_C = 100$	10	A
Pulsed Drain Current	I_{DM}	48	A
Total Power Dissipation	$P_D @ T_C = 25$	3.6	W
Total Power Dissipation	$P_D @ T_A = 25$	0.69	W
Operating Junction Temperature	T_J	-55 to 150	
Storage Temperature	T_{STG}	-55 to 150	
Single Pulse Avalanche Energy @ $L = 0.5mH$	E_{AS}	320	mJ

**Thermal resistance**

Parameter	Symbol	Min.	Typ.	Max.	Unit
Thermal resistance, junction - case	R_{thJC}	-	-	34	$^{\circ}C/W$
Thermal resistance, junction - ambient	R_{thJA}	-	-	180	$^{\circ}C/W$
Soldering temperature, wavesoldering for 10s	T_{sold}	-	-	265	$^{\circ}C$

Parameter	Symbol	Condition	Min.	Typ.	Max.	Unit
Drain-Source Breakdown Voltage	BV_{DSS}	$V_{GS} = 0V, I_D = 250\mu A$	80			V
Gate Threshold Voltage	$V_{GS(TH)}$	$V_{GS} = V_{DS}, I_D = 250\mu A$	2		4	V
Drain-Source Leakage Current	I_{DSS}	$V_{DS} = 80V, V_{GS} = 0V$			1.0	μA
Gate- Source Leakage Current	I_{GSS}	$V_{GS} = \pm 20V, V_{DS} = 0V$			100	nA
Static Drain-source On Resistance		$V_{GS} = 10V, I_D = 16A$				
Forward Transconductance	g_{FS}	$V_{DS} = 25V, I_D = 8A$				
Source-drain voltage	V_{SD}	$I_S = 16A$				

Parameter	Symbol	Condition	Min.	Typ.	Max.	Unit
Input capacitance	C_{iss}		-			

f = 1MHz

Fig.1 Gate-Charge Characteristics

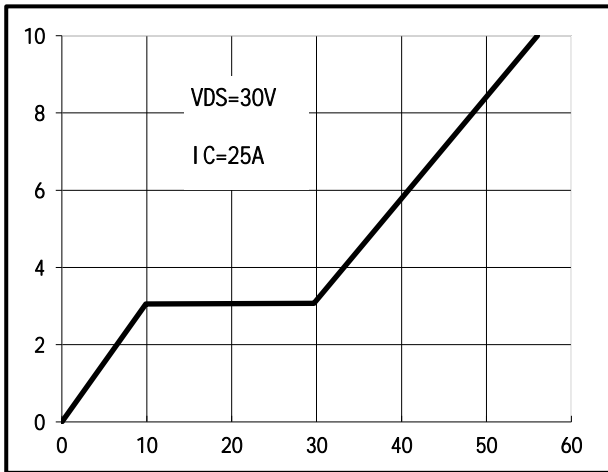

Fig.2 Capacitance Characteristics

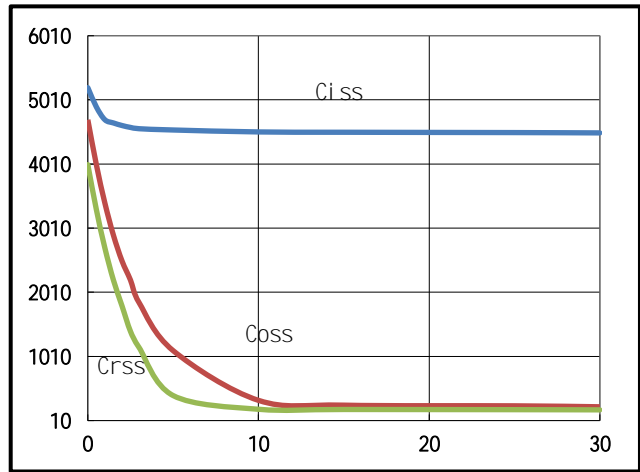

Fig.3 Power Dissipation

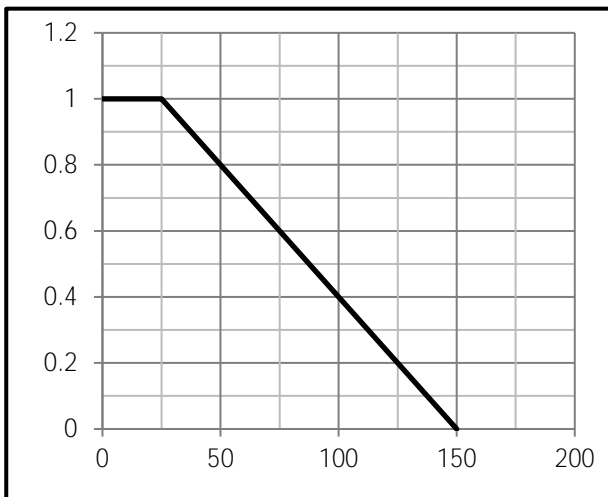

Fig.4 Typical output Characteristics

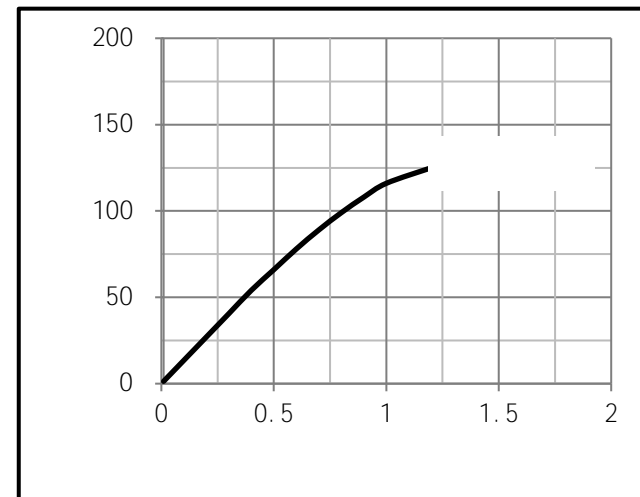

Fig.5 Threshold Voltage V.S Junction Temperature

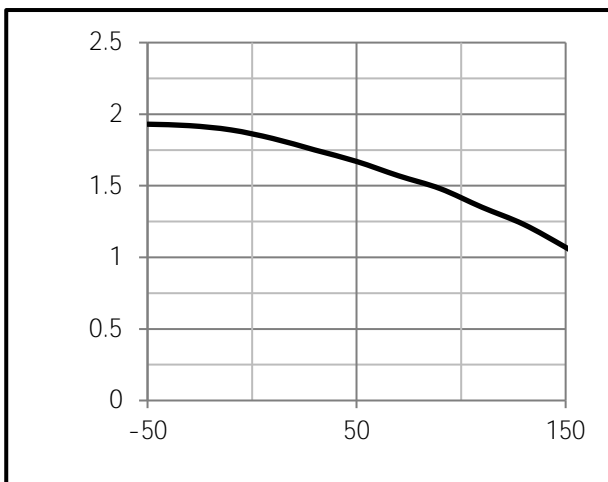
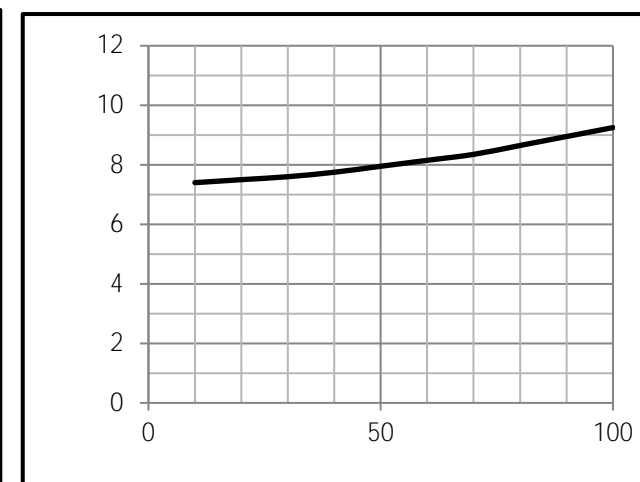

Fig.6 Resistance V.S Drain Current



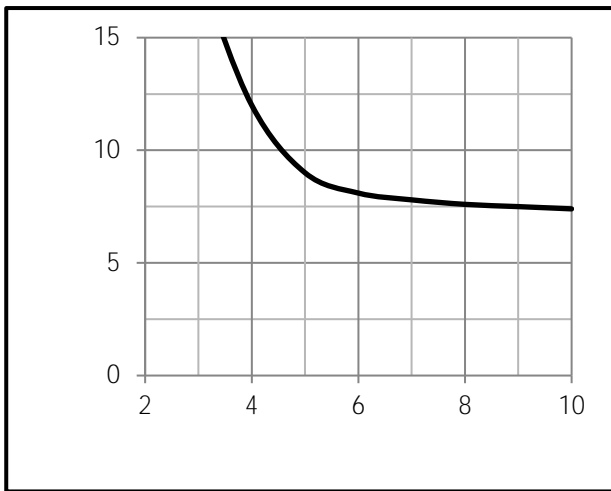

Fig.9 Switching Time Measurement Circuit

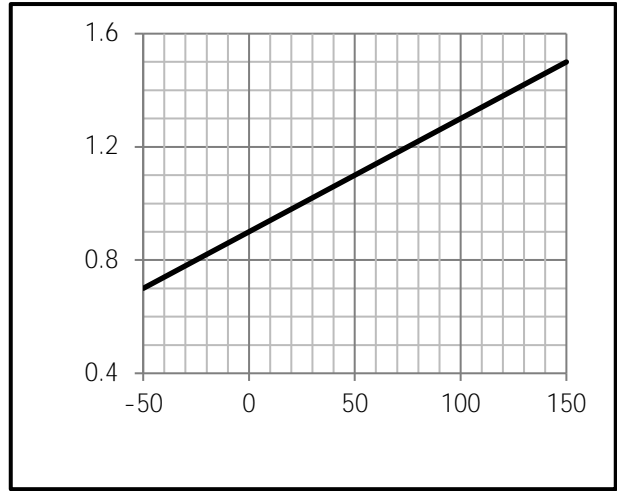

Fig.10 Gate Charge Waveform

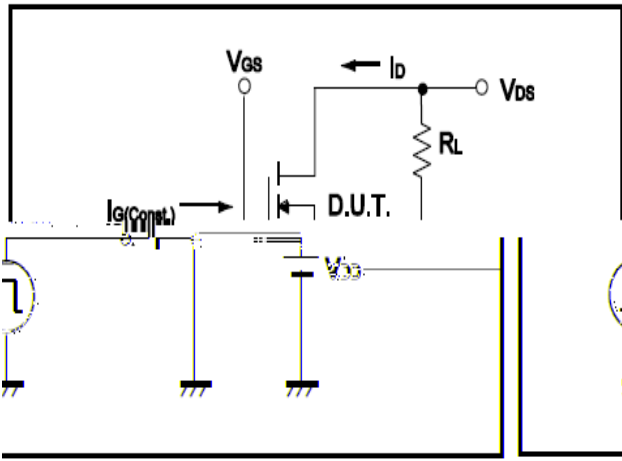

Fig.11 Switching Time Measurement Circuit

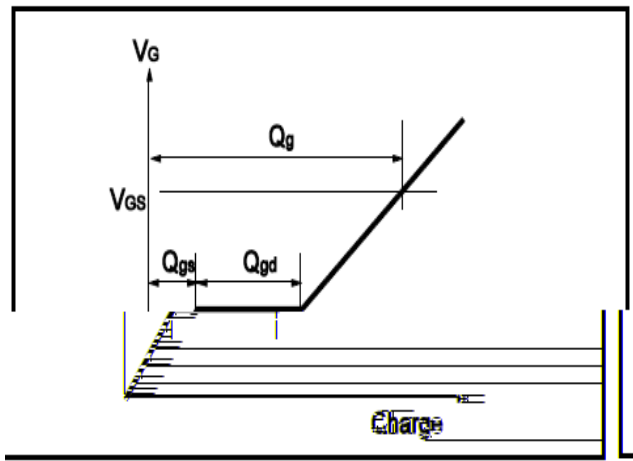
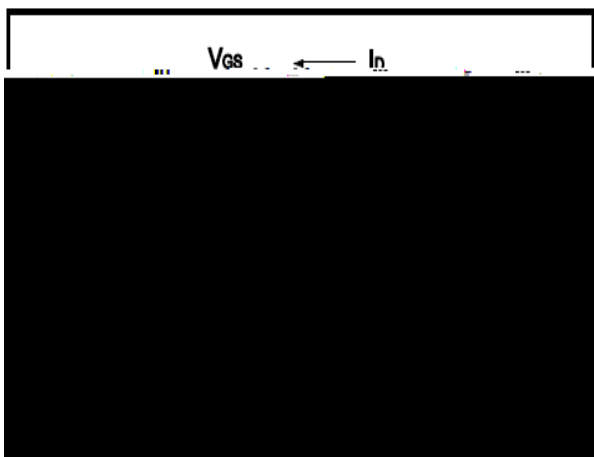

Fig.12 Gate Charge Waveform





(SOP8)

Unit: mm

SYMBOL	min	TYP	max	SYMBOL	min		max
A	4.80		5.25	C	1.30		1.75
A1	0.37		0.49	C1	0.55		0.75
A2		1.27		C2	0.55		0.65
A3		0.41		C3	0.05		0.20
B	5.80		6.20	C4	0.10	0.20	0.23
B1	3.80		4.10	D		1.05	
B2		5.00		D1	0.40		0.62

