

General Description

The ZM120N04S combines advanced trench MOSFET technology with a low resistance package to provide extremely low $R_{DS(ON)}$.

Features

Trench technology
 $R_{DS(ON)}$ to minimize conductive loss

Application

nd Synchronous Rectifier

Product Summary

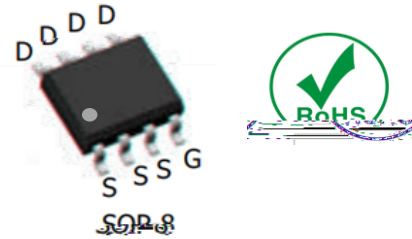
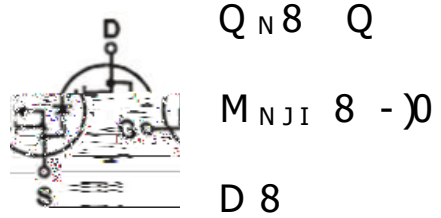

Ordering Information:

Part NO.	- I N
Marking	- I
Packing Information	REEL TAPE
Basic ordering unit (pcs)	4000

Absolute Maximum Ratings $T_C = 25$

Parameter	Symbol	Rating	Unit
Drain-Source Voltage	V_{DS}	40	V
Gate-Source Voltage	V_{GS}	± 20	V
Continuous Drain Current	$I_D @ T_C = 25$	10	A
	$I_D @ T_C = 75$	7.6	A
	$I_D @ T_C = 100$	6.3	A
Pulsed Drain Current	I_{DM}	30	A
Total Power Dissipation	$P_D @ T_C = 25$	3.1	W
Total Power Dissipation	$P_D @ T_A = 25$	0.69	W
Operating Junction Temperature	T_J	-55 to 150	
Storage Temperature	T_{STG}	-55 to 150	
Single Pulse Avalanche Energy @ $L = 0.1mH$	E_{AS}	125	mJ

Thermal resistance

Parameter	Symbol	Min.	Typ.	Max.	Unit
Thermal resistance, junction - case	R_{thJC}	-	-	40	$^{\circ}C/W$
Thermal resistance, junction - ambient	R_{thJA}	-	-	180	$^{\circ}C/W$
Soldering temperature, wavesoldering for 10s	T_{sold}	-	-	265	$^{\circ}C$

Electronic Characteristics

Parameter	Symbol	Condition	Min.	Typ	Max.	Unit
Drain-Source Breakdown Voltage	BV_{DSS}	$V_{GS}=0V, I_D=250\mu A$	40			V
Gate Threshold Voltage	$V_{GS(TH)}$	$V_{GS}=V_{DS}, I_D=250\mu A$	1.2		2.5	V
Drain-Source Leakage Current	I_{DSS}	$V_{DS}=40V, V_{GS}=0V$			1.0	μA
Gate- Source Leakage Current	I_{GSS}	$V_{GS}=\pm 20V, V_{DS}=0V$			100	nA
Static Drain-source On Resistance	M_{NJI}	$V_{GS}=10V, I_D=10A$				
		$V_{GS}=4.5V, I_D=6A$				
Forward Transconductance	g_{FS}	$V_{DS}=25V, I_D=2A$				
Source-drain voltage	VSD	$I_S=10A$			1.28	V

Electronic Characteristics

Parameter	Symbol	Condition	Min.	Typ	Max.	Unit
Input capacitance	C_{iss}	$f = 1MHz$	-	2750	-	μF

Fig.1 Gate-Charge Characteristics

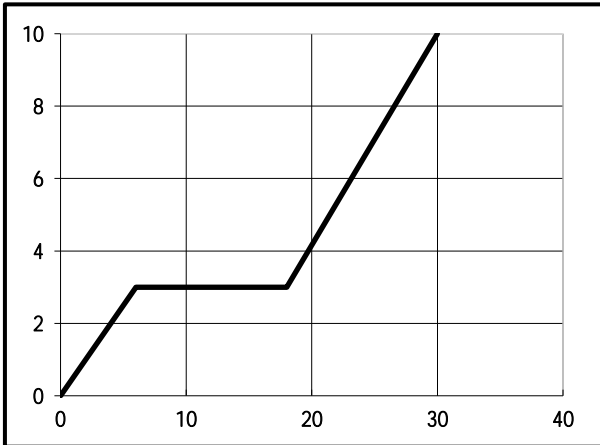

Fig.2 Capacitance Characteristics

Fig.3 Power Dissipation Derating Curve

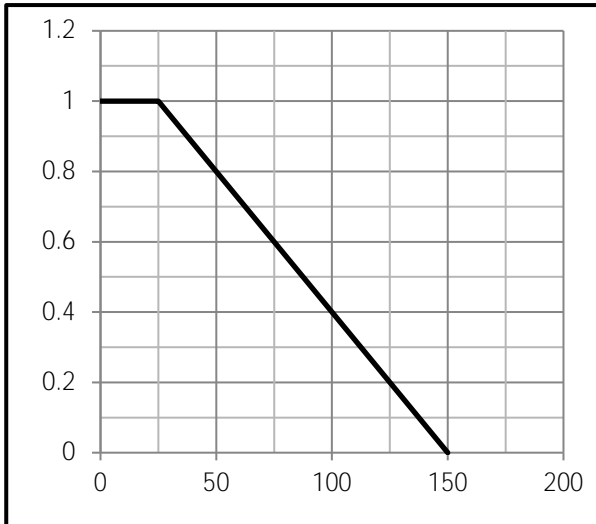

Fig.4 Typical output Characteristics

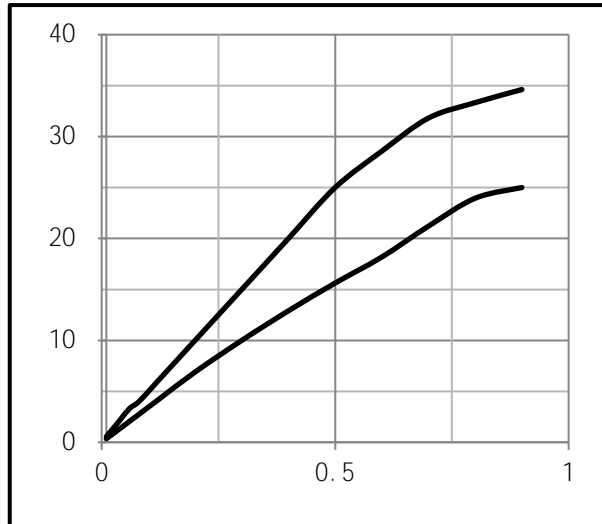
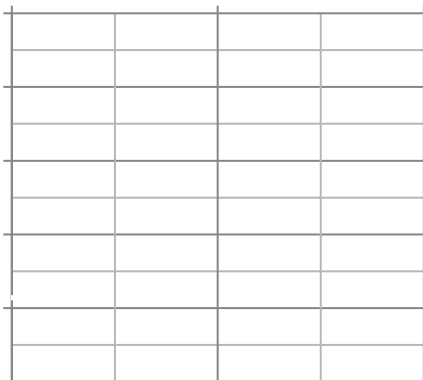

Fig.5 Threshold Voltage V.S Junction Temperature

Fig.6 Resistance V.S Drain Current



A) J (M

QN

N

Q

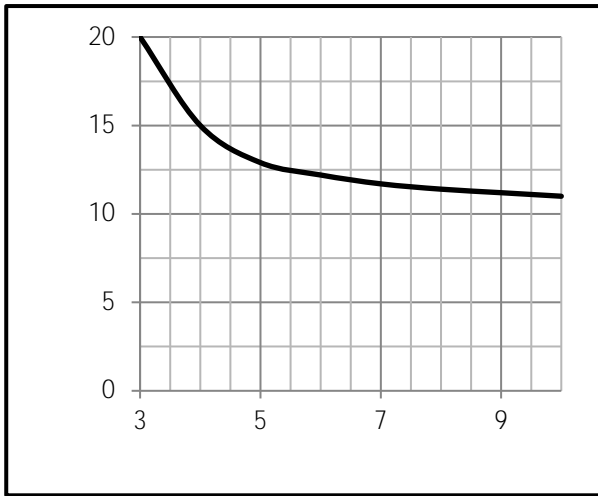

A) J (M

QN

O

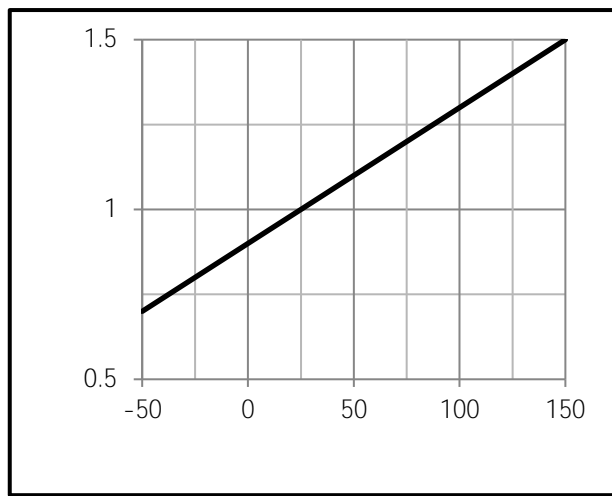

Fig.9 Switching Time Measurement Circuit

Fig.10 Gate Charge Waveform

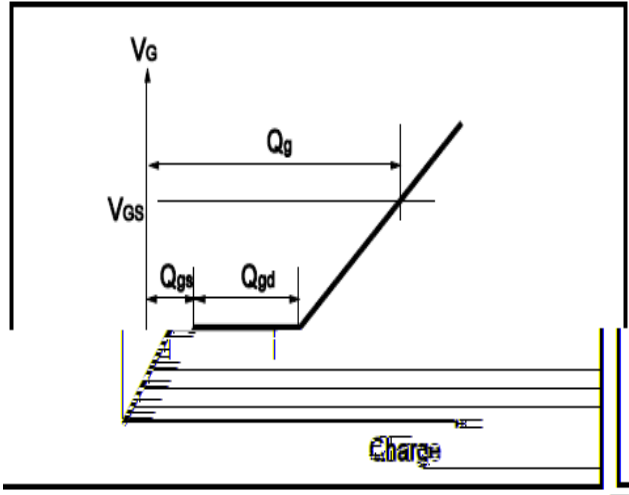
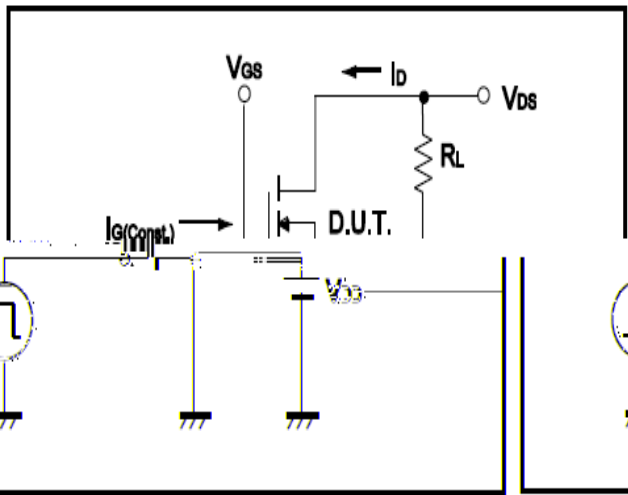
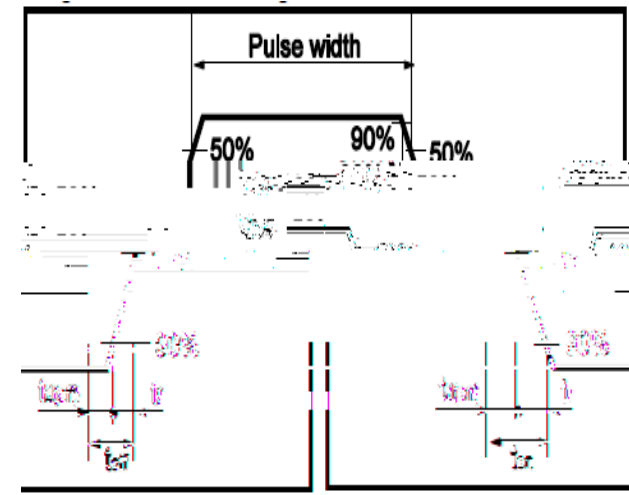
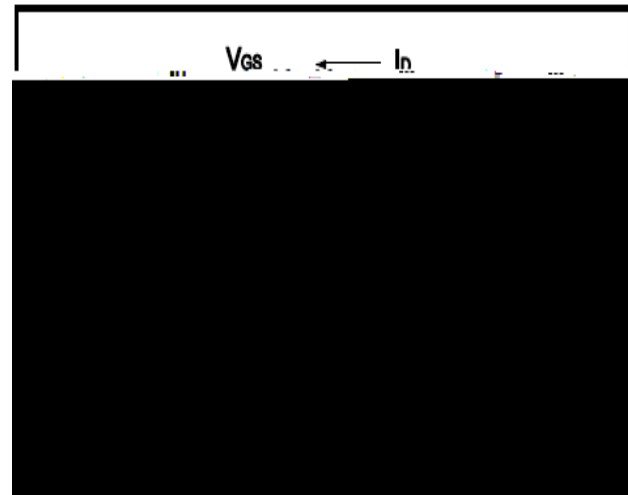

Fig.11 Switching Time Measurement Circuit

Fig.12 Gate Charge Waveform





Dimensions(SOP8)

Unit: mm

SYMBOL	min	TYP	max	SYMBOL	min	max
A	4.80		5.25	C	1.30	1.75
A1	0.37		0.49	C1	0.55	0.75
A2		1.27		C2	0.55	0.65
A3		0.41		C3	0.05	0.20
B	5.80		6.20	C4	0.10	0.20
B1	3.80		4.10	D		1.05
B2		5.00		D1	0.40	0.62

