





Fig.1 Gate-Charge Characteristics

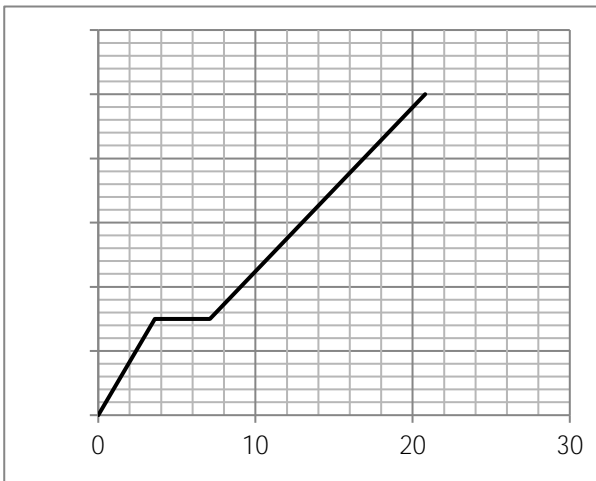

Fig.2 Capacitance Characteristics

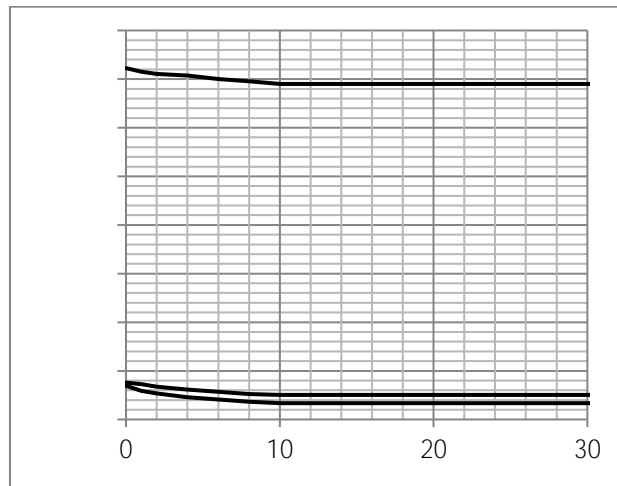

Fig.3 Power Dissipation Derating Curve

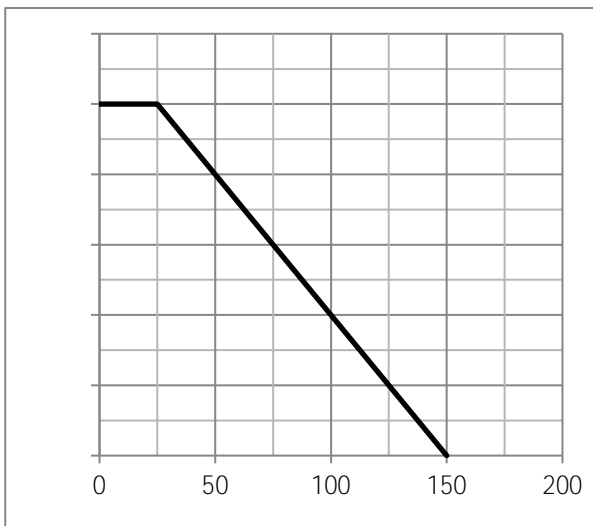

Fig.4 Typical output Characteristics

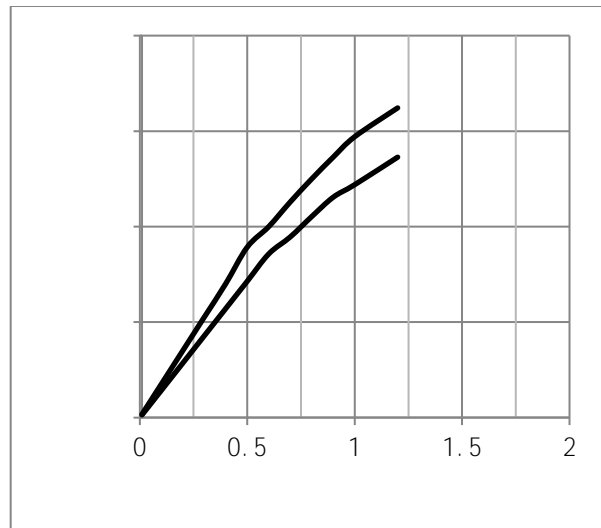

Fig.5 Threshold Voltage V.S Junction Temperature

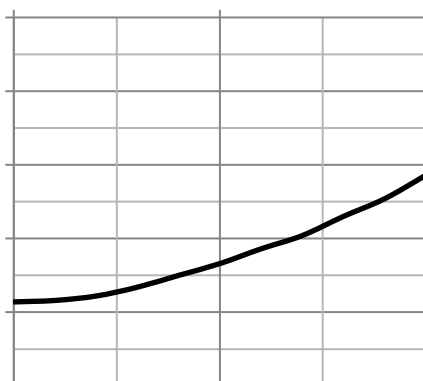

Fig.6 Resistance V.S Drain Current

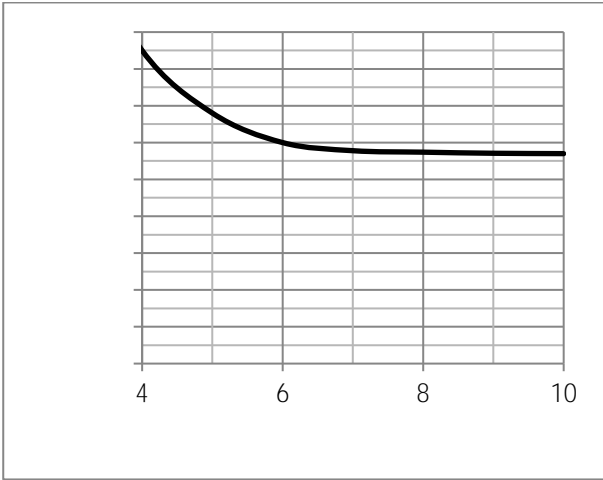

Fig.9 Safe Operating Area

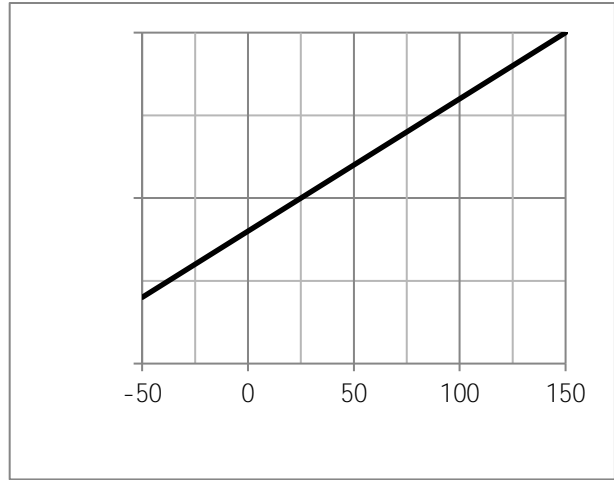

Fig.10 Drain Current

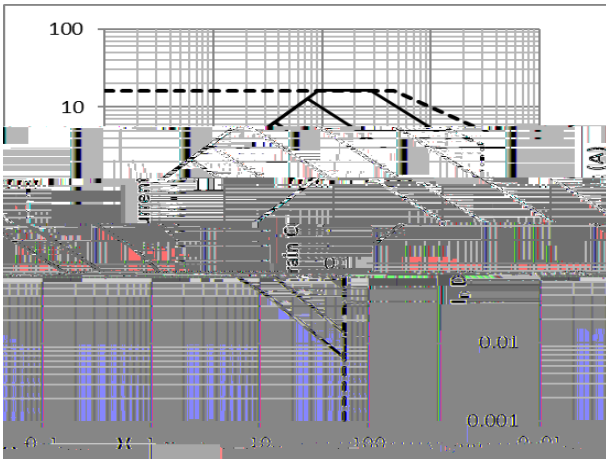

Fig.11 Switching Time Measurement Circuit

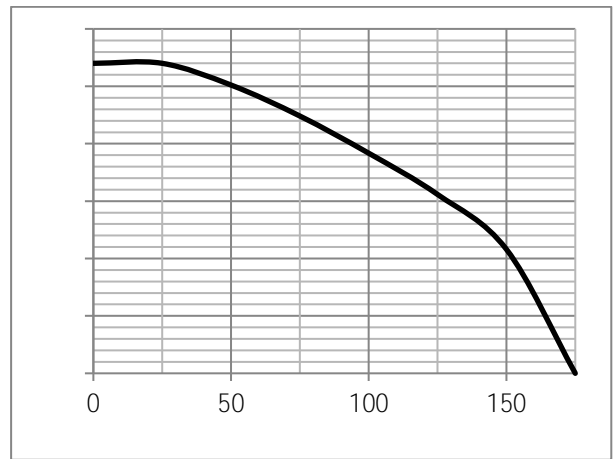
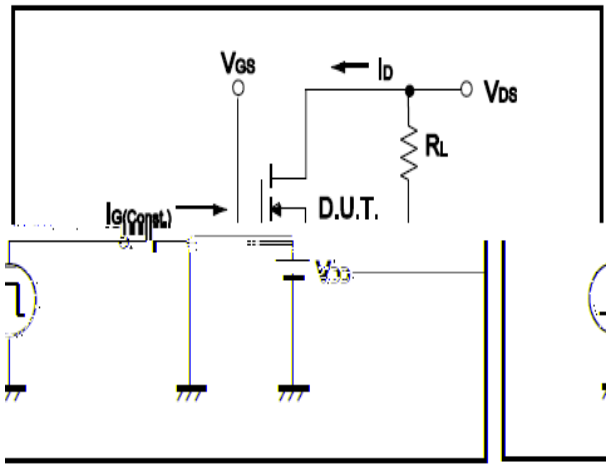

Fig.12 Gate Charge Waveform

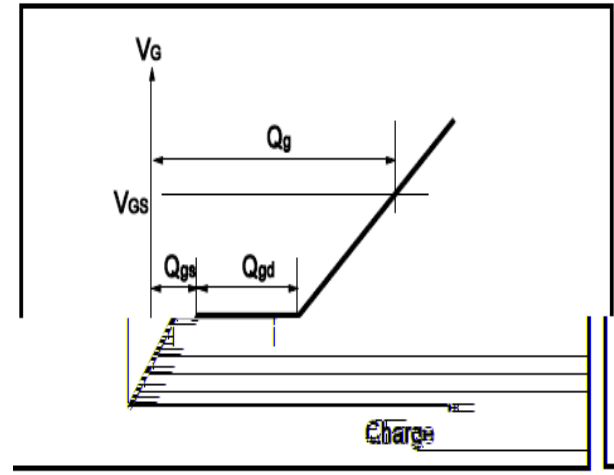

Fig.13 Switching Time Measurement Circuit

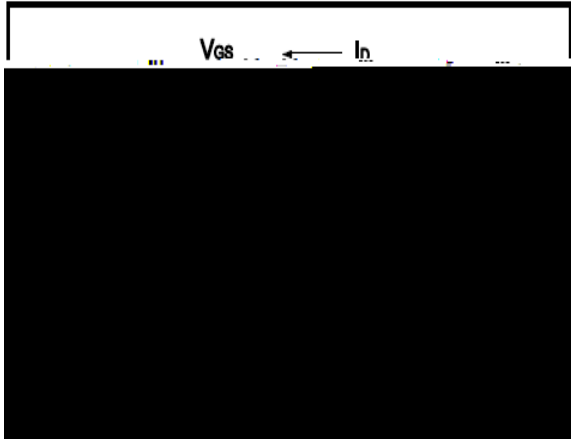

Fig.14 Gate Charge Waveform

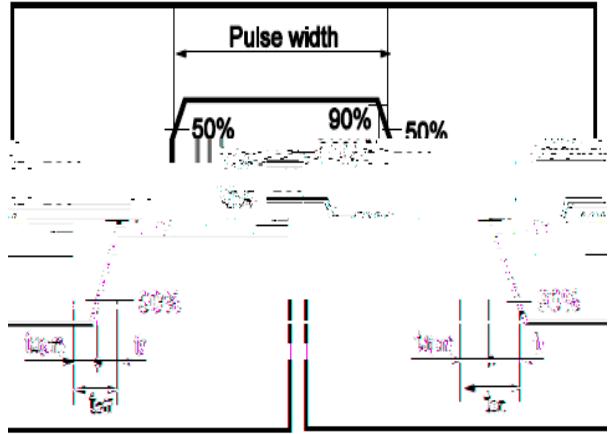

Fig.15 Avalanche Measurement Circuit

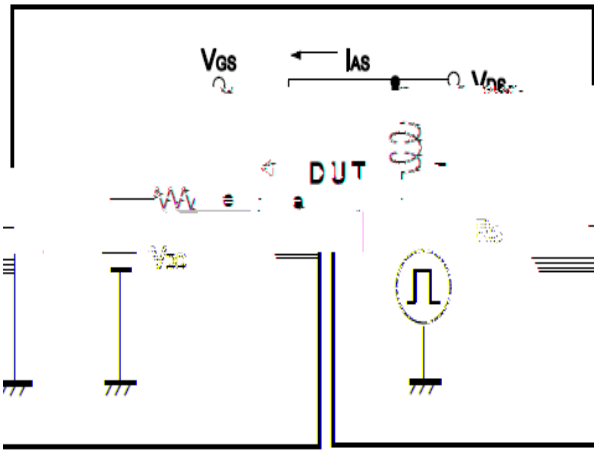

Fig.16 Avalanche Waveform

