



Single Pulse Avalanche Energy
(L=0.5mH,VGS=10V,Rg=25 -

Fig. 12 Capacitance Variation

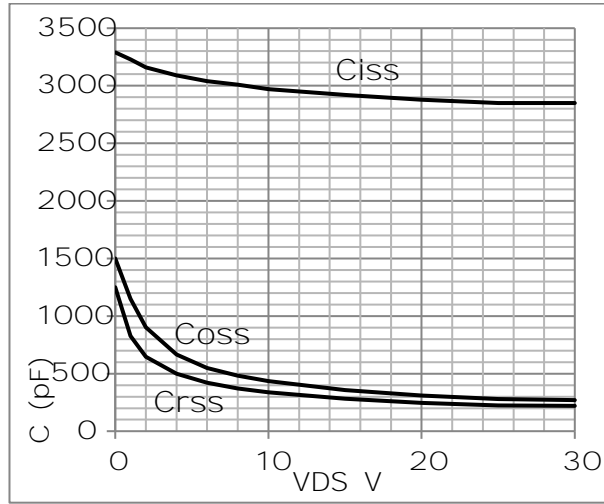
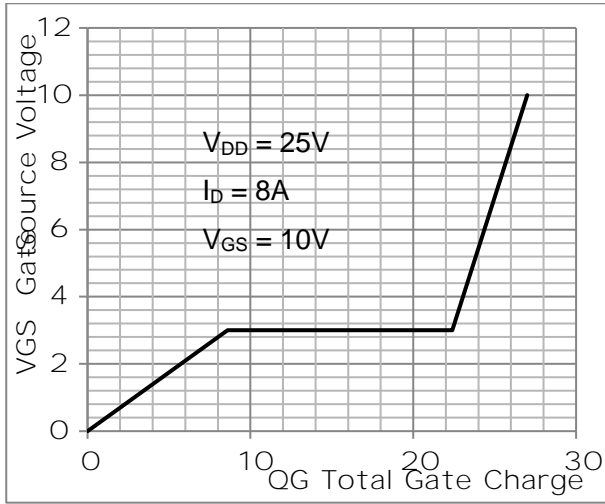

Fig.13 Switching Time Measurement Circuit

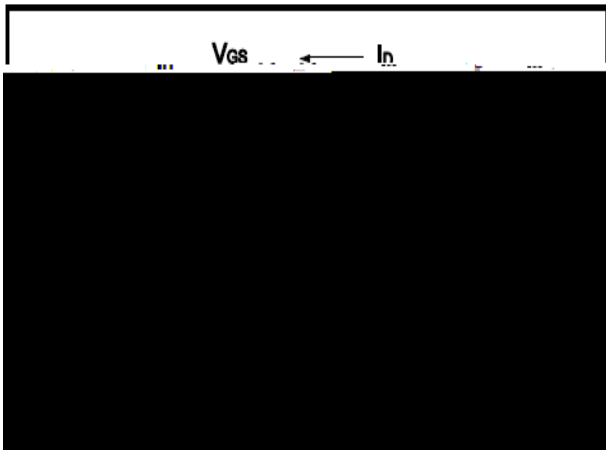

Fig.14 Gate Charge Waveform

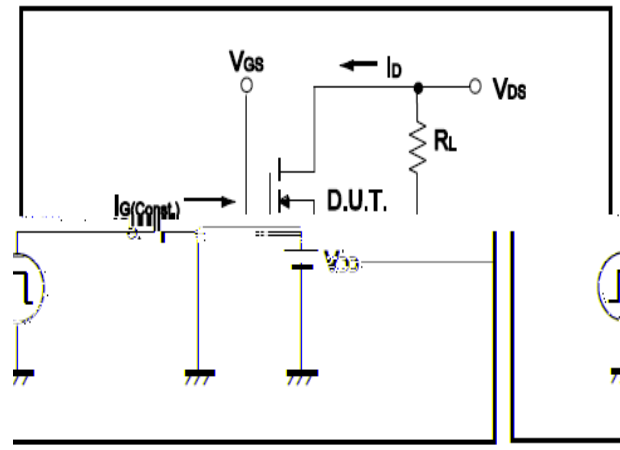

Fig.15 Avalanche Measurement Circuit

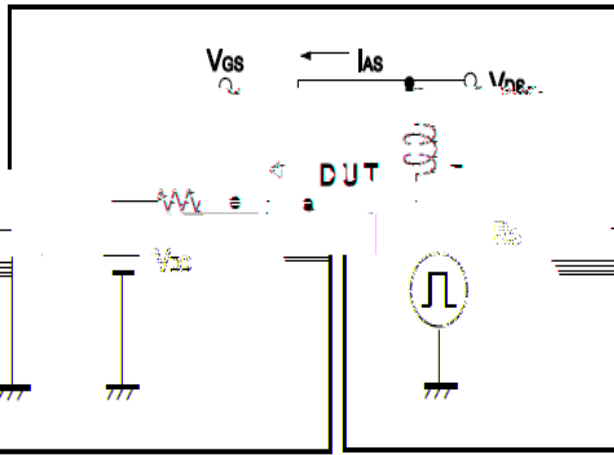

Fig.16 Avalanche Waveform

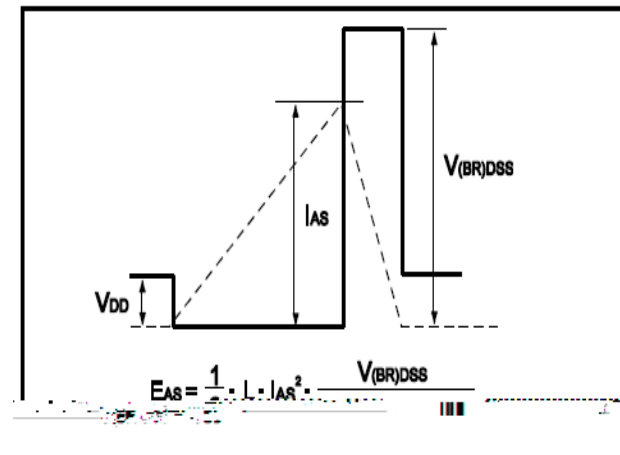
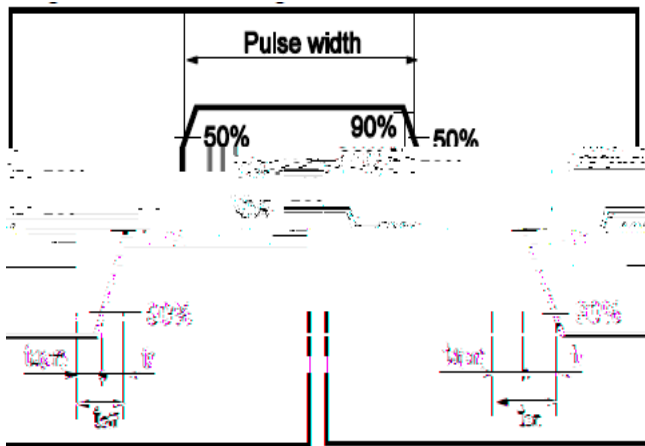



Fig.17 Gate Charge Waveform





sions(DFN3x3)

Unit mm

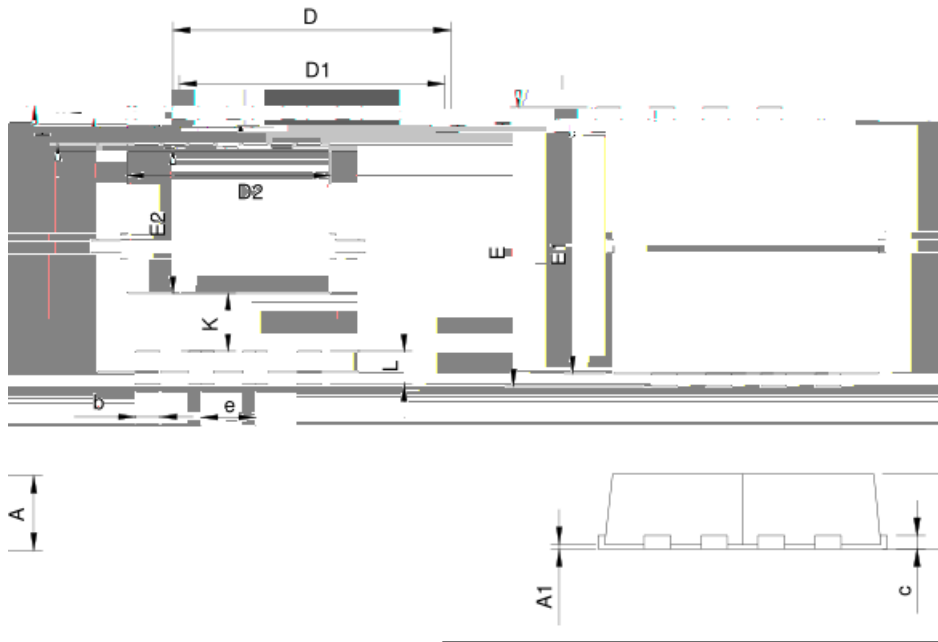

DFN3.3x3.3-8		RECOMMENDED LAND PATTERN			
		DIMENSIONS		DIMENSIONS	
		MIN.	MAX.	MIN.	MAX.
A		0.70	1.00	0.028	0.039
A1		0.00	0.05	0.000	0.002
b				0.25	0.35
c				0.14	0.20
D		3.10	3.50		0.122
D1		3.05	3.25		0.120
D2	2.35	0.65	0.93	0.100	
E	3.16	0.56	0.122	0.138	
E1	2.90	0.10	0.114	0.122	
E2	0.65	0.65	0.34	0.385	
e		0.65 BSC		0.026 BSC	
H	0.32	0.52	0.013	0.020	
K	0.59	0.79	0.023	0.031	
L	0.25	0.35	0.010	0.022	