



Input capacitance	Ciss	f = 1MHz	-	293	-	pF
Output capacitance	Coss		-	28	-	
Reverse transfer capacitance	Crss		-	25	-	

Gate Charge characteristics(T_a = 25)

Parameter	Symbol	Condition	Min.	Typ	Max.	Unit
Total gate charge	Qg	V _{DD} =15V	-	8	-	nC
Gate - Source charge	Qgs	I _D = 4A	-	0.4	-	
Gate - Drain charge	Qgd	V _{GS} = 10V	-	1.5	-	

P Channel Electronic Characteristics

Parameter	Symbol	Condition	Min.	Typ	Max.	Unit
Drain-Source Breakdown Voltage	BV _{DSS}	V _{GS} =0V, I _D =-250uA	-20			V
Gate Threshold Voltage	V _{GS(TH)}	V _{GS} =V _{DS} , I _D =-250uA	-0.5	-0.8	-1.2	V
Drain-Source Leakage Current	I _{DSS}	V _{DS} =-20V, V _{GS} =0V			-1.0	uA
Gate- Source Leakage Current	I _{GSS}	V _{GS} =±12V, V _{DS} =0V			±100	nA
Static Drain-source On Resistance		V _{GS} =-4.5V, I _D =-3A		70	85	mΩ
		V _{GS} =-2.5V, I _D =-2.5A		80	110	mΩ
Forward Transconductance	g _{FS}	V _{DS} =-10V, I _D =-1A		1.5		s

Electronic Characteristics

Parameter	Symbol	Condition	Min.	Typ	Max.	Unit
Input capacitance	Ciss	f = 1MHz	-	430	-	pF
Output capacitance	Coss		-	74	-	
Reverse transfer capacitance	Crss		-	68	-	

Gate Charge characteristics(T_a = 25)

Parameter	Symbol	Condition	Min.	Typ	Max.	Unit
Total gate charge	Qg	V _{DD} = -15V	-	10.7	-	nC
Gate - Source charge	Qgs	I _D = -3A	-	0.6	-	
Gate - Drain charge	Qgd	V _{GS} = -10V	-	2.2	-	

N Channel characteristics curve

Fig.1 Power Dissipation

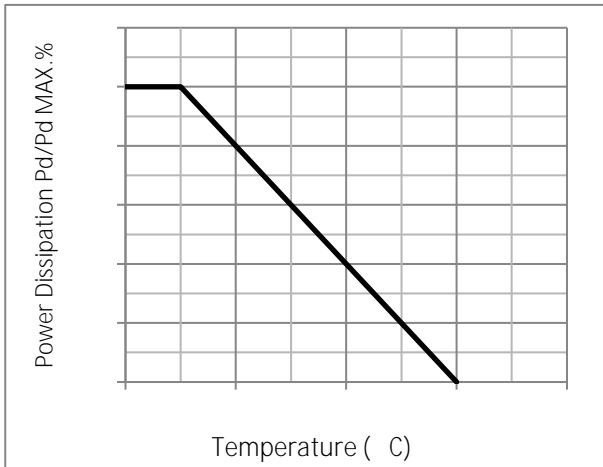

Fig.2 Typical output Characteristics

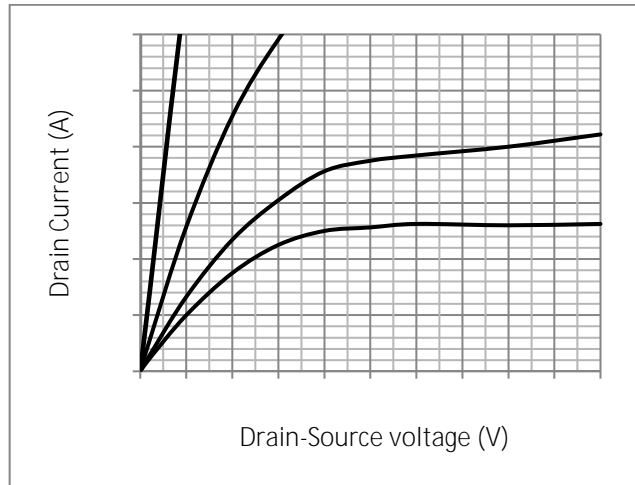

Fig.3 Threshold Voltage V.S Junction Temperature

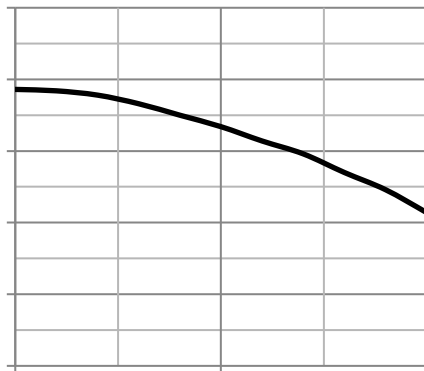

Fig.4 Resistance V.S Drain Current

Fig.7 Gate-Charge Characteristics

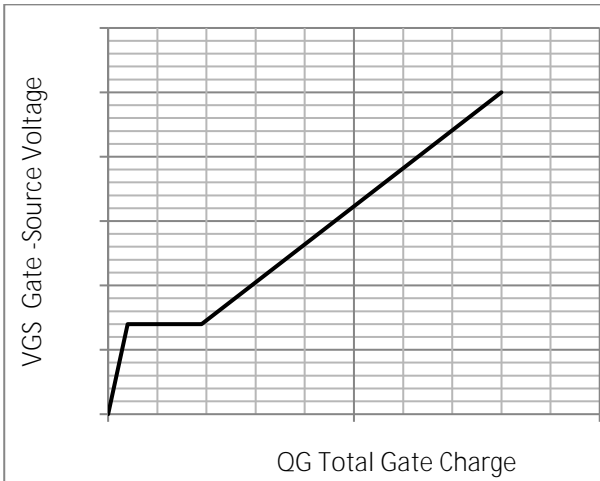

Fig.8 Capacitance Characteristics

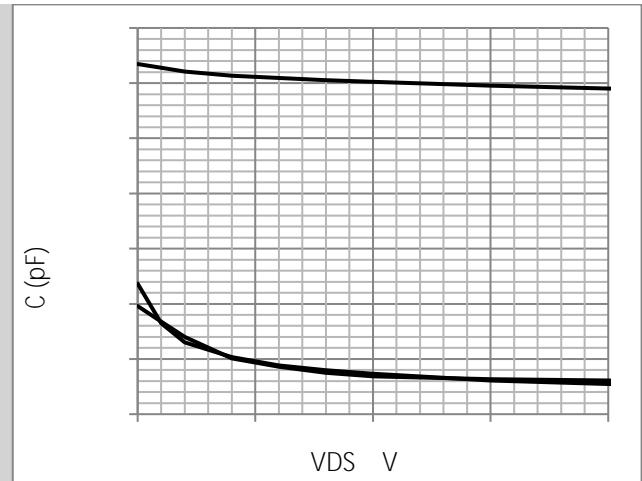
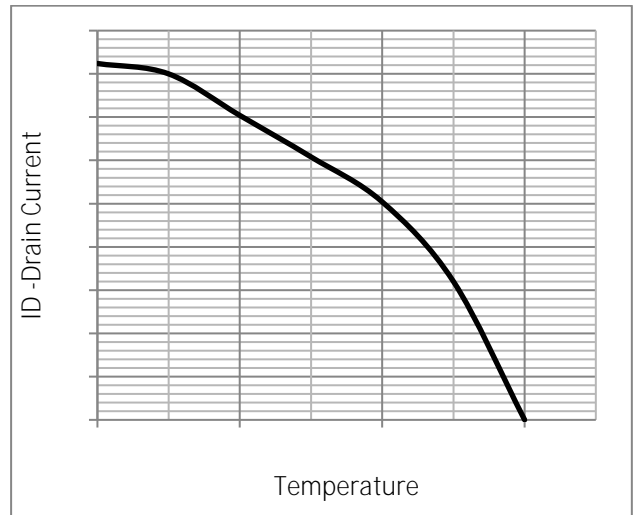

Fig.9 SOA Maximum Safe Operating Area

Fig.10 ID-Junction Temperature



P Channel characteristics curve

Fig.1 Power Dissipation Derating Curve

Fig.2 Typical output Characteristics

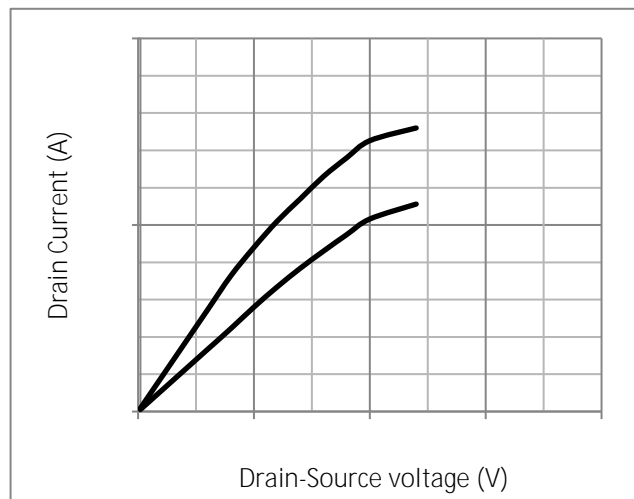

Fig.9 SOA Maximum Safe Operating Area

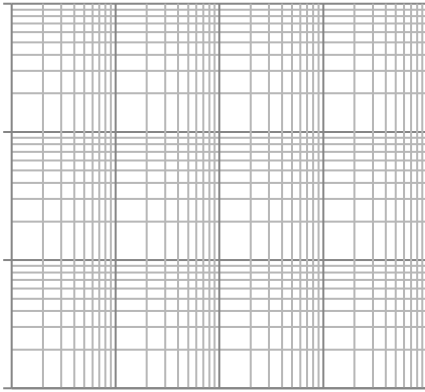
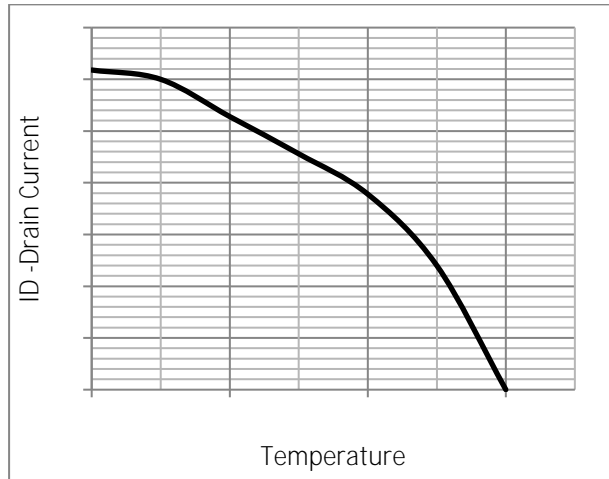

Fig.10 ID-Junction Temperature



Test Circuit

Fig.1 Switching Time Measurement Circuit

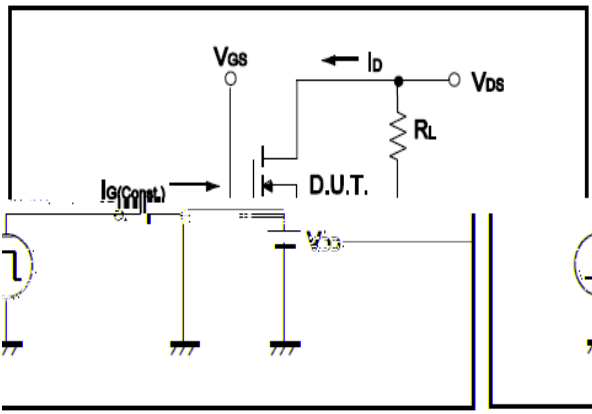

Fig.2 Gate Charge Waveform

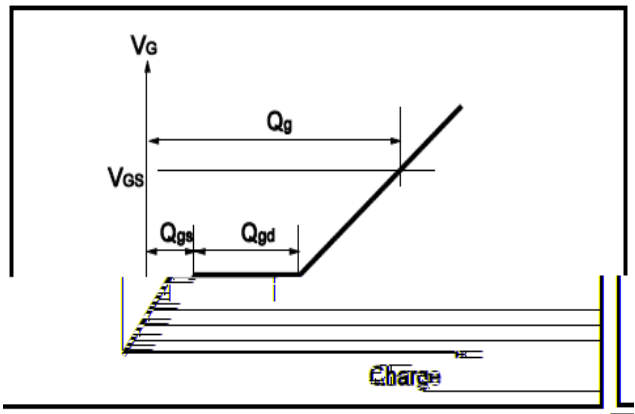

Fig.3 Switching Time Measurement Circuit

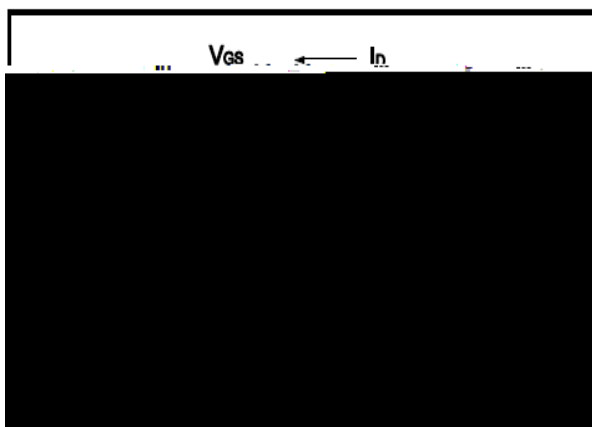

Fig.4 Gate Charge Waveform

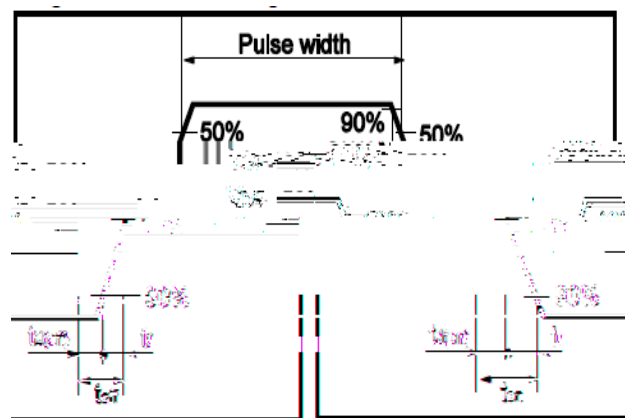

Fig.5 Avalanche Measurement Circuit

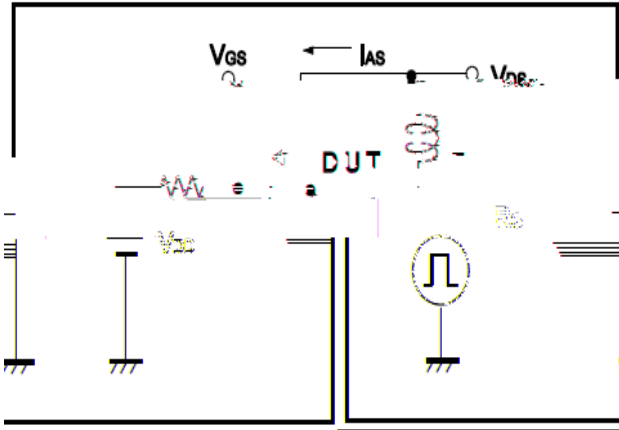

Fig.6 Avalanche Waveform

