

General Description

It combines advanced MOSFET technology with a low resistance package to provide extremely low $R_{DS(ON)}$.

Features

- device constructure
- $R_{DS(ON)}$ to minimize conduction loss
- fast switching

Application

- Synchronous Rectification for AC-DC/DC-DC converter
- Power Tools

Product Summary



$V_{DS} = 60V$

$R_{DS(ON)} = 5.2m$

$I_D = 80A$

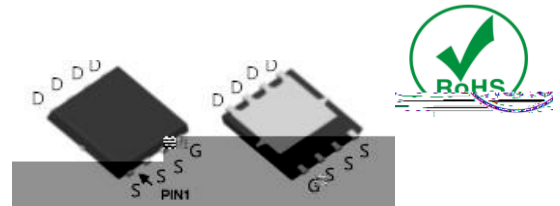

DFN5

Ordering Information:

Part NO.	ZMS052N06N
Marking	ZMS052N06
Packing Information	REEL TAPE
Basic ordering unit (pcs)	3000

Absolute Maximum Ratings $T_C = 25$

Parameter	Symbol	Rating	Unit
Drain-Source Voltage	V_{DS}	60	V
Gate-Source Voltage	V_{GS}	± 20	V
Continuous Drain Current	$I_{D@TC=25}$	80	A
	$I_{D@TC=75}$	61	A
	$I_{D@TC=100}$	50	A
Pulsed Drain Current	I_{DM}	240	A
Total Power Dissipation	$P_D@TC=25$	85	W
Total Power Dissipation	$P_D@TA=25$	3.4	W
Operating Junction Temperature	T_J	-55 to 150	
Storage Temperature	T_{STG}	-55 to 150	
Single Pulse Avalanche Energy	E_{AS}	280	mJ

Thermal resistance

Parameter	Symbol	Min.	Typ.	Max.	Unit
Thermal resistance, junction - case	R_{thJC}			1.5	$^{\circ}C/W$
Thermal resistance, junction - ambient	R_{thJA}	-	-	37	$^{\circ}C/W$
Soldering temperature, wavesoldering for 10s	T_{sold}	-	-	265	$^{\circ}C$

Electronic Characteristics

Parameter	Symbol	Condition	Min.	Typ	Max.	Unit
Drain-Source Breakdown Voltage	BV_{DSS}	$V_{GS}=0V, I_D=250\mu A$	60			V
Gate Threshold Voltage	$V_{GS(TH)}$	$V_{GS}=V_{DS}, I_D=250\mu A$	1.5		2.5	V
Drain-Source Leakage Current	I_{DSS}	$V_{DS}=0.8 BV_{DSS}, V_{GS}=0V$			1.0	μA
Gate- Source Leakage Current	I_{GSS}	$V_{GS}=\pm 20V, V_{DS}=0V$			100	nA
Static Drain-source On Resistance	$R_{DS(ON)}$	$V_{GS}=10V, I_D=10A$				
		$V_{GS}=4.5V, I_D=5A$				
Forward Transconductance	g_{FS}	$V_{DS}=25V, I_D=10A$				
Source-drain voltage	V_{SD}	$I_S=10A$				

Dynamic Characteristics

Parameter	Symbol	Condition	Min.	Typ	Max.	Unit
Input capacitance	C_{iss}		-	1910	-	pF



Reverse Recovery Time

t_{RR}

V_{DD}

Fig.5 Threshold Voltage V.S Junction Temperature

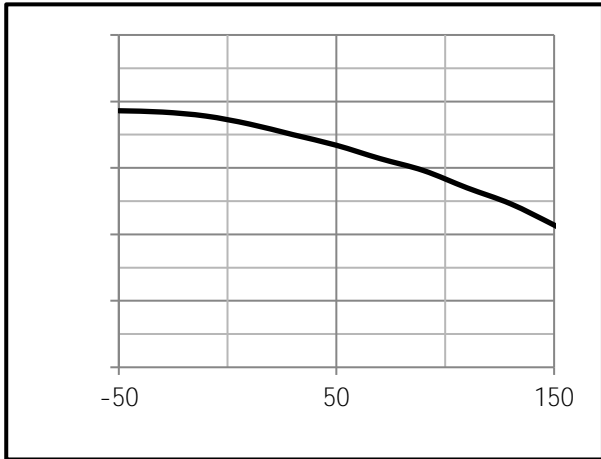

Fig.6 Resistance V.S Drain Current

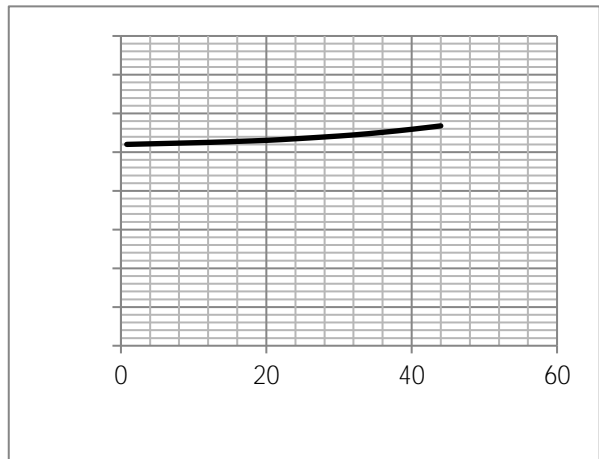

Fig.7 On-Resistance VS Gate Source Voltage

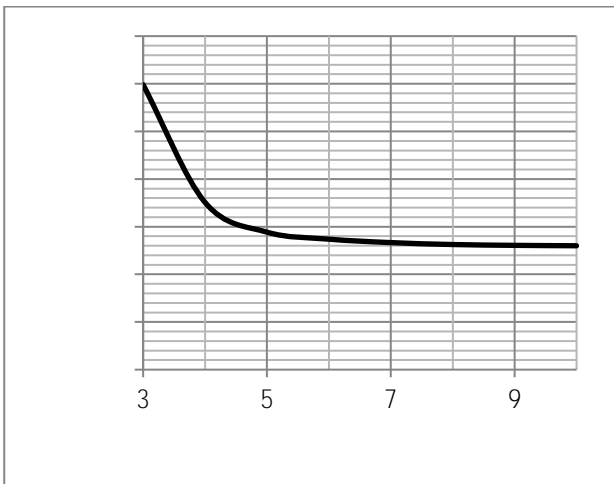

Fig.8 On-Resistance V.S Junction Temperature

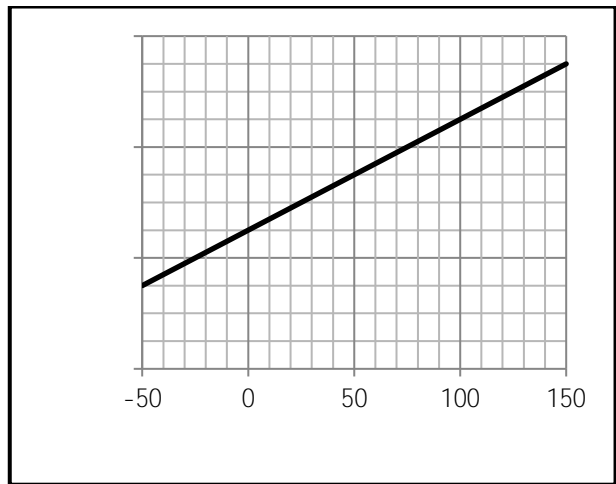

Fig.9 SOA Maximum Safe Operating Area

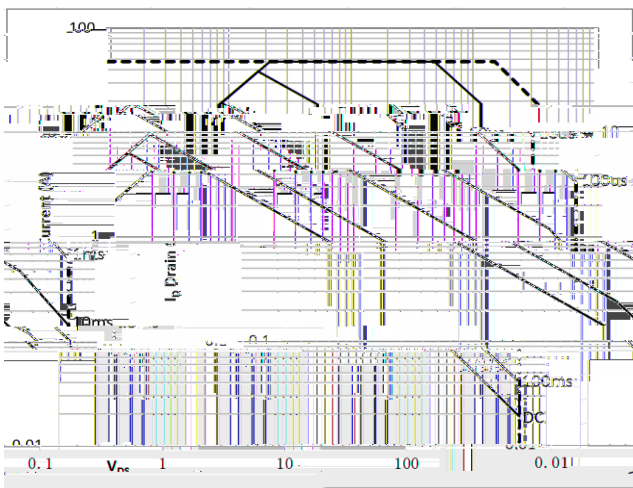

Fig.10 ID-Junction Temperature

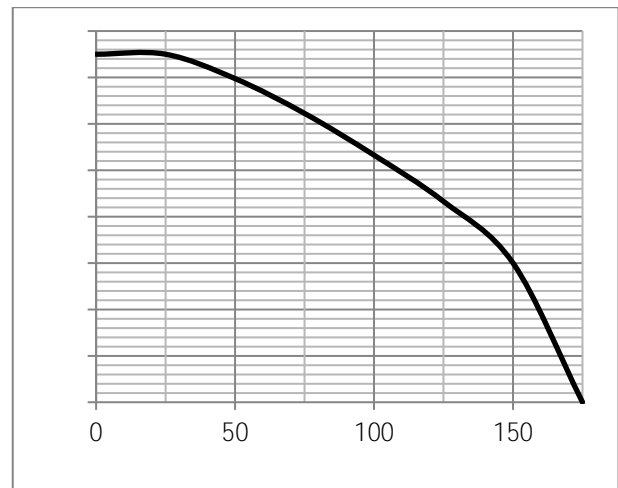

Fig.11 Switching Time Measurement Circuit

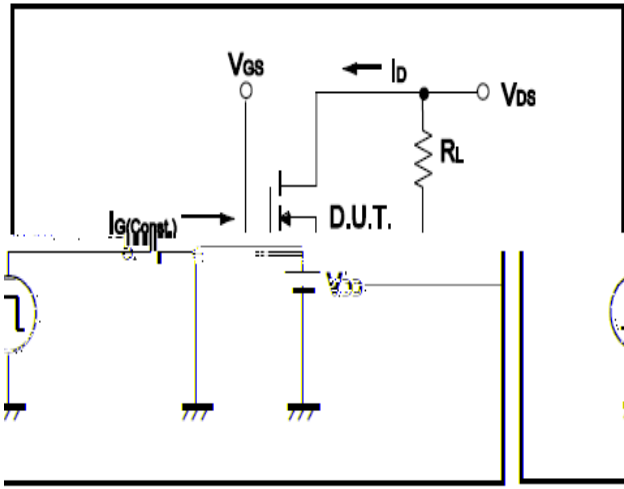

Fig.12 Gate Charge Waveform

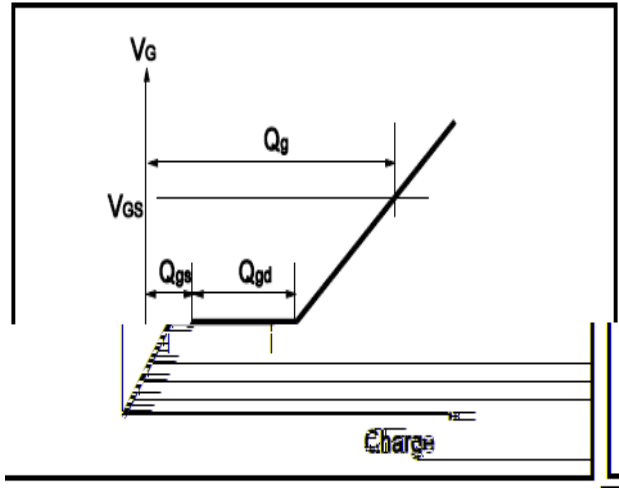

Fig.13 Switching Time Measurement Circuit

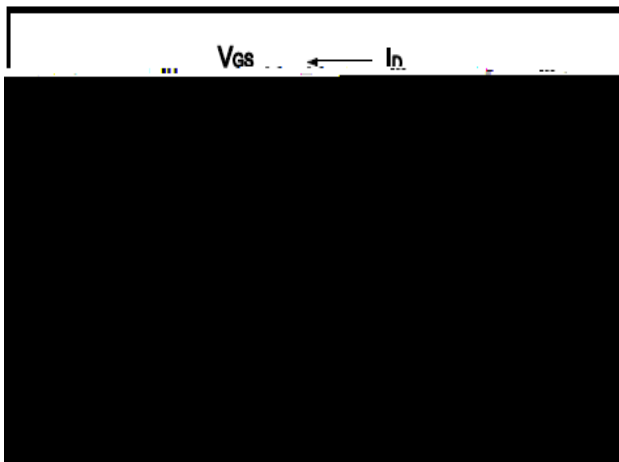
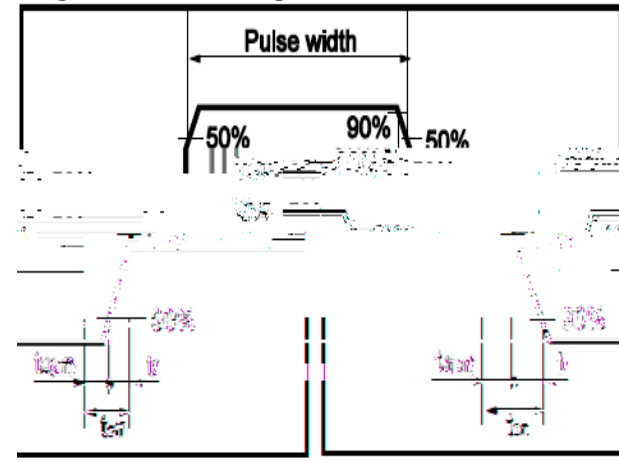

Fig.14 Gate Charge Waveform





Dimensions DFN5x6