

General Description

It combines advanced trench MOSFET technology with a low resistance package to provide extremely low $R_{DS(ON)}$. It combines one N channel MOSFET and one P channel MOSFET.

Features

Trench technology
 $R_{DS(ON)}$ to minimize conductive loss

Dual DIE in one package

Application

Power Management in Notebook Computer
 BLDC Motor driver

Product Summary

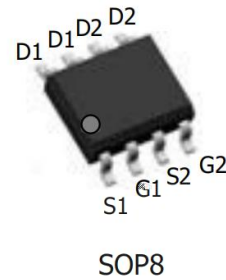
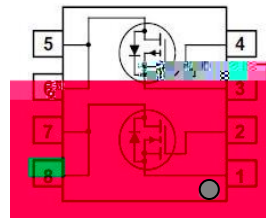

Ordering Information:

Part NO.	ZMC88401S
Marking	ZMC88401
Packing Information	REEL TAPE
Basic ordering unit (pcs)	4000

N Channel Absolute Maximum Ratings $T_C = 25$

Parameter	Symbol	Rating	Unit
Drain-Source Voltage	V_{DS}	40	V
Gate-Source Voltage	V_{GS}	20	V
Continuous Drain Current	$I_D @ T_C = 25$	11	A
	$I_D @ T_C = 75$	8.4	A
	$I_D @ T_C = 100$	6.9	A
Pulsed Drain Current	I_{DM}	33	A
Total Power Dissipation	$P_D @ T_C = 25$	20.8	W
Total Power Dissipation	$P_D @ T_A = 25$	1.9	W
Operating Junction Temperature	T_J	-55 to 150	
Storage Temperature	T_{STG}	-55 to 150	
Single Pulse Avalanche Energy	E_{AS}	46	mJ

P Channel Absolute Maximum Ratings $T_C = 25$

Parameter	Symbol	Rating	Unit
Drain-Source Voltage	V_{DS}	-40	V
Gate-Source Voltage	V_{GS}	± 20	V
Continuous Drain Current	$I_D @ T_C = 25$	-10	A
	$I_D @ T_C = 75$	-7.6	A
	$I_D @ T_C = 100$	-6.3	A
Pulsed Drain Current	I_{DM}	-30	A
Total Power Dissipation	$P_D @ T_C = 25$	20.8	W
Total Power Dissipation	$P_D @ T_A = 25$	1.9	W
Operating Junction Temperature	T_J	-55 to 150	
Storage Temperature	T_{STG}	-55 to 150	
Single Pulse Avalanche Energy	E_{AS}	70	mJ

Thermal resistance

Parameter	Symbol	Min.	Typ.	Max.	Unit
Thermal resistance, junction - case	R_{thJC}	-	-	6	$^{\circ}C/W$
Thermal resistance, junction - ambient	R_{thJA}	-	-	65	$^{\circ}C/W$
Soldering temperature, wavesoldering for 10s	T_{sold}	-	-	260	$^{\circ}C$

N Channel Electronic Characteristics

Parameter	Symbol	Condition	Min.	Typ.	Max.	Unit
Drain-Source Breakdown Voltage	BV_{DSS}	$V_{GS} = 0V, I_D = 250\mu A$	40			V
Gate Threshold Voltage	$V_{GS(TH)}$	$V_{GS} = V_{DS}, I_D = 250\mu A$	1.2		2.5	V
Drain-Source Leakage Current	I_{DSS}	$V_{DS} = 40V, V_{GS} = 0V$			1.0	μA
Gate- Source Leakage Current	I_{GSS}	$V_{GS} = \pm 20V, V_{DS} = 0V$			100	nA
Static Drain-source On Resistance		$V_{GS} = 10V, I_D = 11A$		9	11.6	
		$V_{GS} = 4.5V, I_D = 9A$		13.61		

**N Channel Dynamic Characteristics**

Parameter	Symbol	Condition	Min.	Typ	Max.	Unit
Input capacitance	C_{iss}	f = 1MHz	-	1930	-	pF
Output capacitance	C_{oss}		-	154	-	
Reverse transfer capacitance	C_{rss}		-	110	-	
Total gate charge	Q_g	$V_{DD} = 25V$	-	30	-	nC
Gate - Source charge	Q_{gs}	$I_D = 10A$	-	5.9	-	
Gate - Drain charge	Q_{gd}	$V_{GS} = 10V$	-	5.4	-	

P Channel Electronic Characteristics

Parameter	Symbol	Condition	Min.	Typ	Max.	Unit
Drain-Source Breakdown Voltage	BV_{DSS}	$V_{GS} = 0V, I_D = -250\mu A$	-40			V

N Channel characteristics curve

Fig.1 Power Dissipation Derating Curve

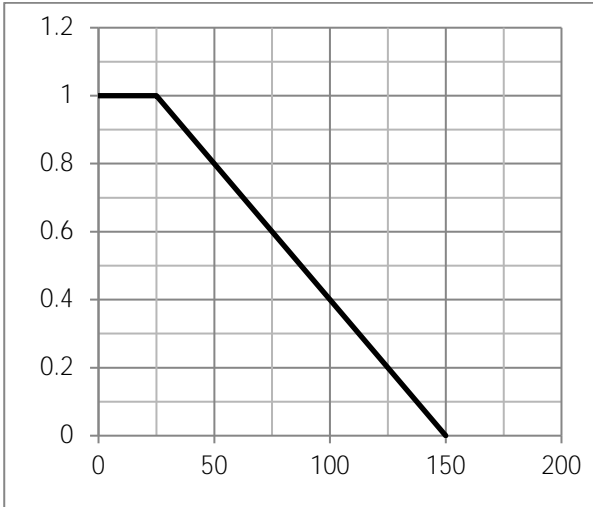

Fig.2 Typical output Characteristics

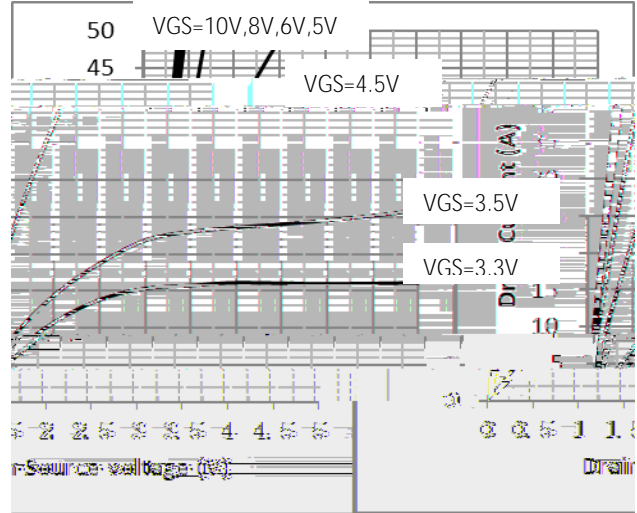

Fig.3 Threshold Voltage V.S Junction Temperature

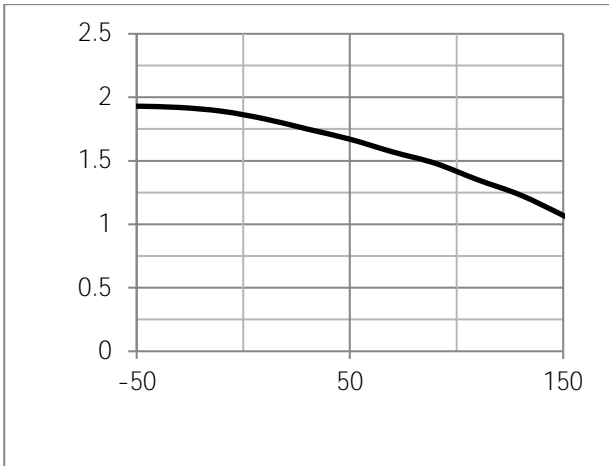
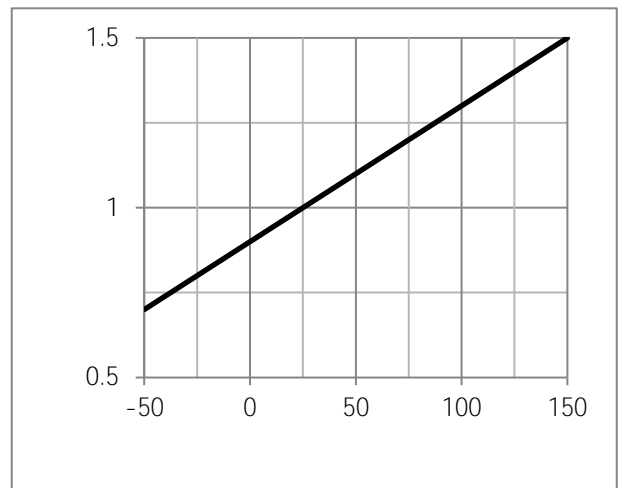
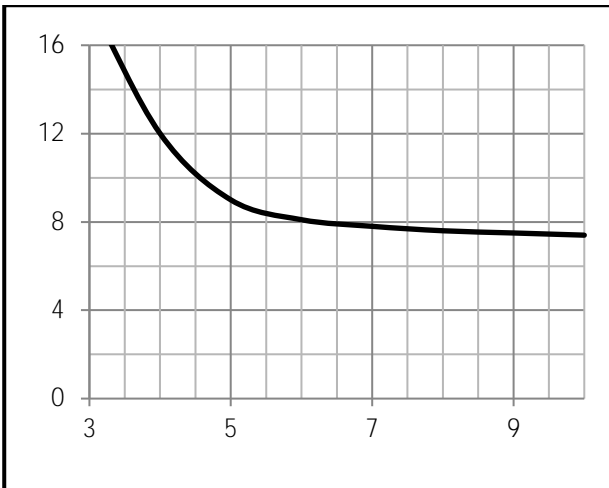
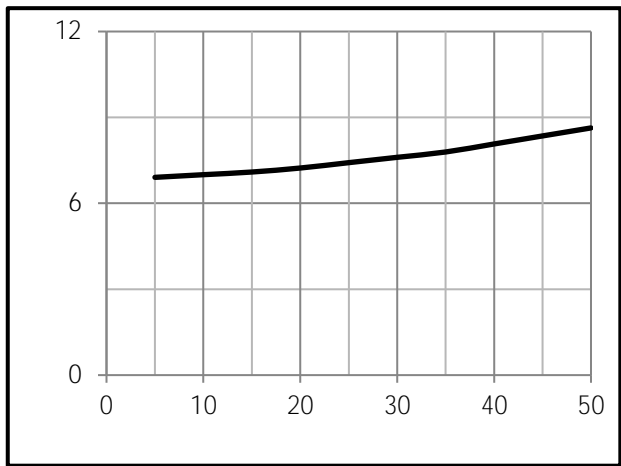

Fig.4 Resistance V.S Drain Current



P Channel characteristics curve

Fig.1 Power Dissipation Derating Curve

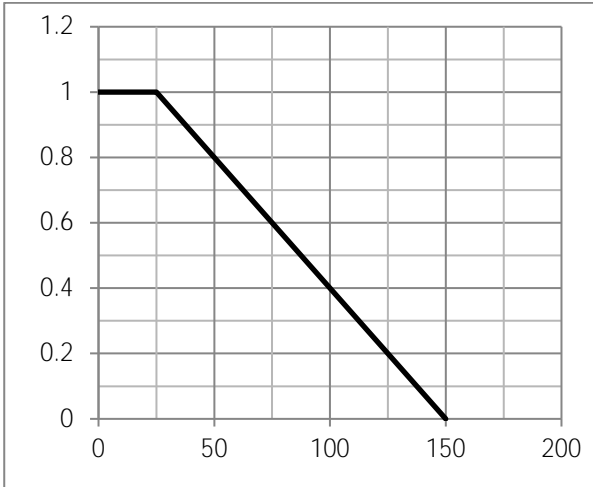

Fig.2 Typical output Characteristics

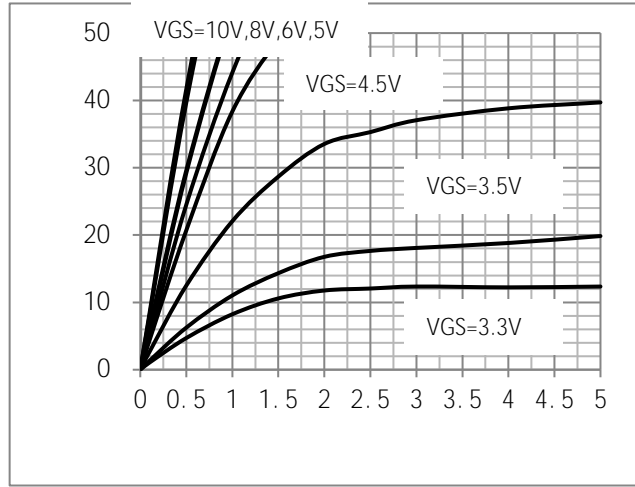

Fig.3 Threshold Voltage V.S Junction Temperature

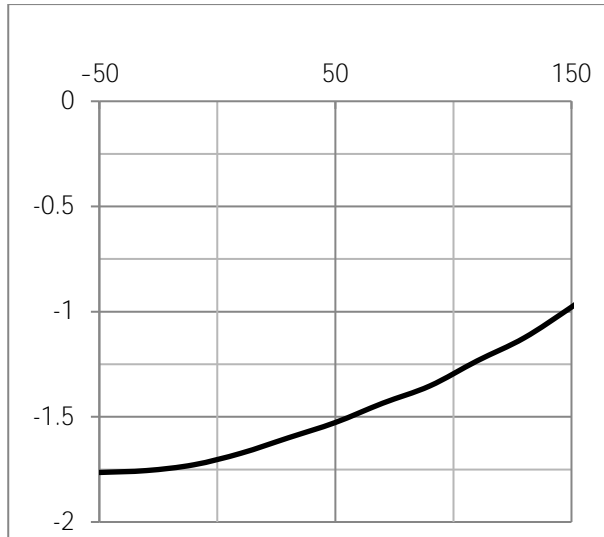
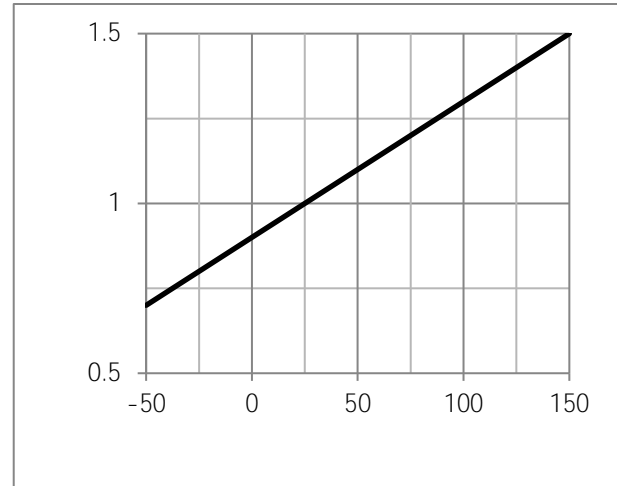
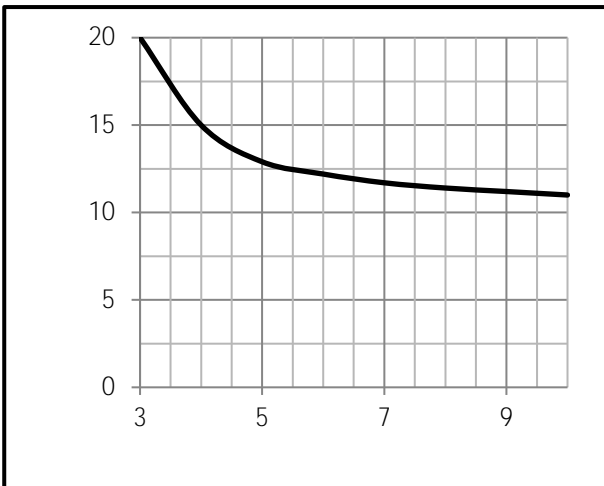
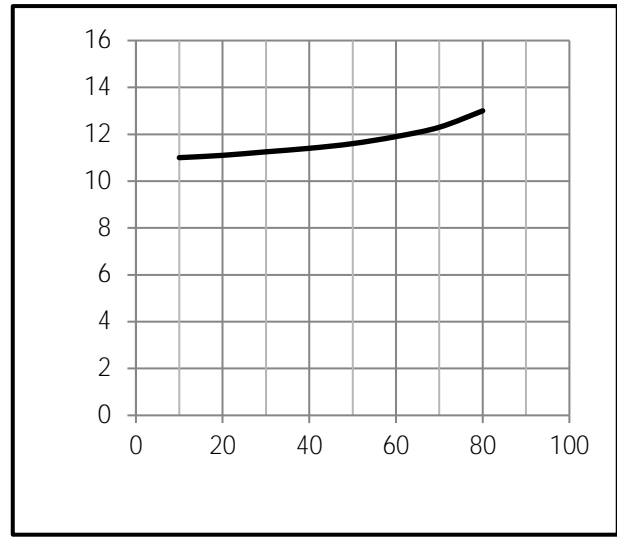

Fig.4 Resistance V.S Drain Current



Test Circuit

Fig.1 Switching Time Measurement Circuit

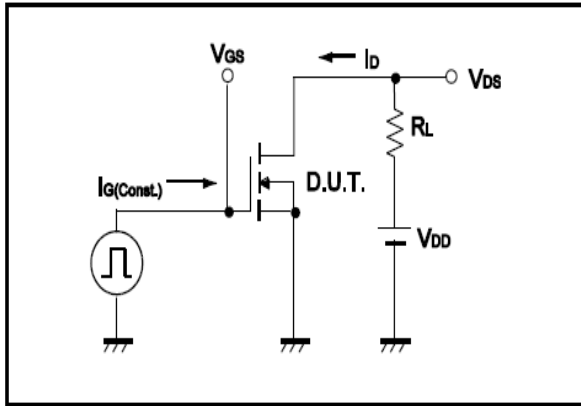

Fig.2 Gate Charge Waveform

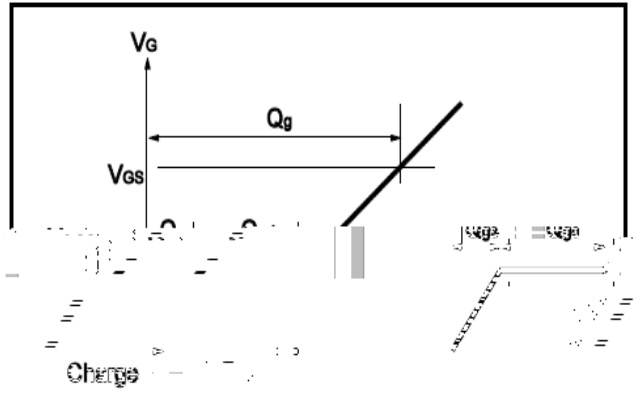

Fig.3 Switching Time Measurement Circuit

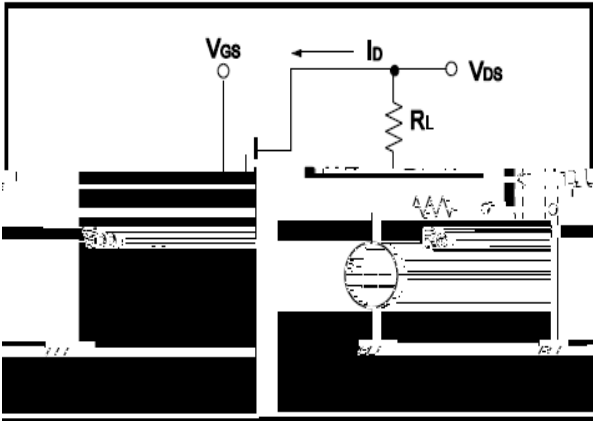

Fig.4 Gate Charge Waveform

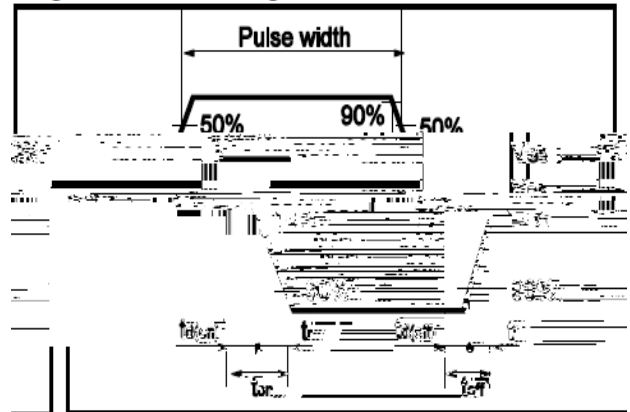

Fig.5 Avalanche Measurement Circuit

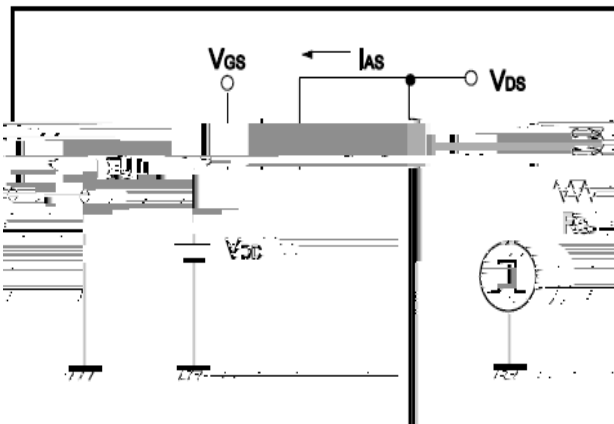
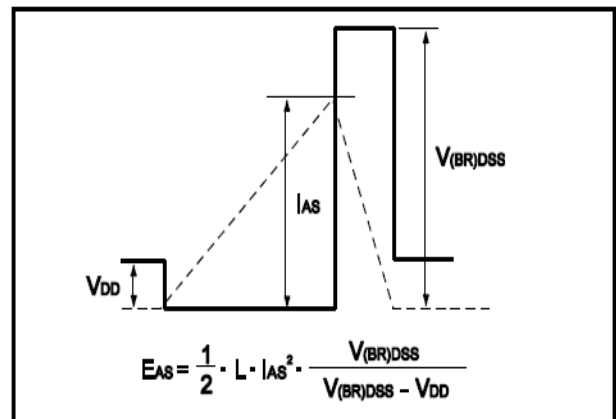

Fig.6 Avalanche Waveform





Dimensions(SOP8)

Unit: mm

SYMBOL	min	TYP	max	SYMBOL	min		max
A	4.80		5.25	C	1.30		1.75
A1	0.37		0.49	C1	0.55		0.75
A2		1.27		C2	0.55		0.65
A3		0.41		C3	0.05		0.20
B	5.80		6.20	C4	0.10	0.20	0.23
B1	3.80		4.10	D		1.05	
B2		5.00		D1	0.40		0.62

